

SUWANNEE RIVER WATER MANAGEMENT DISTRICT

ENVIRONMENTAL RESOURCE PERMIT APPLICANT'S HANDBOOK VOLUME II

(DESIGN REQUIREMENTS FOR STORMWATER
TREATMENT AND MANAGEMENT SYSTEMS)

FOR USE WITHIN THE GEOGRAPHIC LIMITS OF THE
SUWANNEE RIVER WATER MANAGEMENT DISTRICT

Volume II is incorporated by reference in 62-330, F.A.C. and 40B-400, F.A.C.



TABLE OF CONTENTS

PART I – INTRODUCTION, ORGANIZATION, APPLICABILITY

- 1.1 Introduction, Criteria, Policy and Purpose
 - 1.1.1 Introduction
 - 1.1.2 Criteria Objectives
 - 1.1.3 Policy and Purpose
- 1.2 Thresholds
- 1.3 Exemptions

PART II – GENERAL CRITERIA

- 2.1 Definitions & Acronyms
 - 2.1.1 Definitions
 - 2.1.2 Acronyms
- 2.2 Fees & Surety
 - 2.2.1 Fees
 - 2.2.2 Surety
- 2.3 General Design and Performance Criteria
 - 2.3.1 Pre Application Conference
- 2.4 Professional Certification
- 2.5 Surveys
- 2.6 Computer Models
- 2.7 Flexibility for State Transportation Projects and Facilities
- 2.8 Redevelopments and Retrofits of Existing Surface Water Management Systems

PART III – STORMWATER QUANTITY/FLOOD CONTROL

- 3.1 General
 - 3.1.1 Factors Influencing Water Quantity
 - 3.1.2 Antecedent Moisture Conditions
- 3.2 Design Storms
- 3.3 Discharge Rates and Volumes
 - 3.3.1 Methodologies for Calculating Discharge
- 3.4 Recovery
 - 3.4.1 Percolation and Water Table
 - 3.4.2 Mounding
- 3.5 Compensating Stormwater Treatment
- 3.6 Flood Zone Criteria
 - 3.6.1 Static Systems
 - 3.6.2 Floodplain Storage and Conveyance
 - 3.6.3 Importer/Exporter
 - 3.6.4 Compensating Storage
 - 3.6.5 Dynamic Systems
 - 3.6.6 No Rise Requirements
- 3.7 Tailwater Conditions
 - 3.7.1 Topographical Information
 - 3.7.2 Surface Profiles
- 3.8 Low Flow & Base Flow Maintenance

PART IV – STORMWATER QUALITY

- 4.1 General
 - 4.1.1 Factors Influencing Water Quality
- 4.2 Dewatering
- 4.3 State Water Quality Standards
- 4.4 Recovery
- 4.5 Erosion and Sediment Control
 - 4.5.1 Side Slopes
- 4.6 Pollutant Control
 - 4.6.1 Pre Treatment
 - 4.6.2 Oil and Grease Control
- 4.7 Runoff Coefficients and Curve Numbers for Stormwater Systems

PART V – BEST MANAGEMENT PRACTICES

- 5.1 Retention Pond Design Criteria and Guidelines
 - 5.1.1 Description
 - 5.1.2 Criteria
- 5.2 Dry Detention Pond Design Criteria and Guidelines
 - 5.2.1 Description
 - 5.2.2 Criteria
- 5.3 Exfiltration Trench Systems Design Criteria and Guidelines
 - 5.3.1 Description
 - 5.3.2 Criteria
- 5.4 Wet Detention Pond Design Criteria and Guidelines
 - 5.4.1 Description
 - 5.4.2 Criteria
 - 5.4.3 Permanent Pool
- 5.5 Swales Systems Design Criteria and Guidelines
 - 5.5.1 Description
 - 5.5.2 Criteria
- 5.6 Vegetated Natural Buffers Design Criteria and Guidelines
 - 5.6.1 Description
 - 5.6.2 Criteria
- 5.7 Borrow Pits & Ponds Design Criteria and Guidelines
 - 5.7.1 Description
 - 5.7.2 Criteria
- 5.8 Dams & Impoundments Design Criteria and Guidelines
 - 5.8.1 Description
 - 5.8.2 Criteria
 - 5.8.3 Embankment Slope Stability
 - 5.8.4 Construction Standards
 - 5.8.5 Principal Spillways
 - 5.8.6 Emergency Spillways
 - 5.8.7 Reservoir Regulation
- 5.9 Sensitive Karst Areas Design Criteria and Guidelines
 - 5.9.1 Background of the Sensitive Karst Area
 - 5.9.2 Hydrogeology of the Sensitive Karst Area
 - 5.9.3 Criteria

PART VI – OPERATION AND MAINTENANCE

- 6.1 General
- 6.2 Entity Requirements
- 6.3 Operation Phase and Release of Bond
- 6.4 Inspections and Reporting
- 6.5 Compliance
- 6.6 Enforcement

PART VII – APPENDICES

Appendix

- A - District map and boundaries
- B - Design Storms

PART I – INTRODUCTION, ORGANIZATION, APPLICABILITY

1.1 Introduction, Criteria, Policy and Purpose

1.1.1 Introduction

This **Applicant’s Handbook Volume II** accompanies Chapter 62-330 F.A.C. and the **Applicant’s Handbook—Volume I** (General and Environmental).” **Applicant’s Handbook Volume I** is applicable to all environmental resource permit applications, and provides:

- Background information on the environmental resource permit (ERP) program, including points of contact;
- A summary of the statutes and rules that are used to authorize and implement the ERP program;
- A summary of the types of permits, permit thresholds, and exemptions; and
- A discussion of the environmental criteria used for ERP evaluations.

This Volume is designed to be applicable only to those ERP applications that involve the design of a water management system that requires a permit as provided in 62-330, F.A.C.

The environmental resource permit program regulates all types of storm water management systems, including dams, impoundments, reservoirs, appurtenant work, or works, and dredging or filling, as those terms are defined in Sections 373.403(13) and (14), F.S., or any combination thereof. These terms are defined in Sections 373.019, and 373.403, F.S., Chapter 62-346.030, F.A.C., and in Section 2.1 of this Volume. A stormwater management system is defined in Sections 373.403(10) and 403.031(16), F.S., as a system that is designed and constructed or implemented to control discharges which are necessitated by rainfall events, incorporating methods to collect, convey, store, absorb, inhibit, treat, use, or reuse water to prevent or reduce flooding, over drainage, environmental degradation, and water pollution or otherwise affect the quantity and quality of discharges from the system.

Therefore, this Volume generally is not applicable to activities that do not generate more than an incidental amount of stormwater runoff, such as:

- Dredging and filling to construct such things as most “stand-alone” seawalls and docks and “in water” types of activities, such as channel dredging. This would not include dredging and filling in wetlands or other surface waters to construct such things as bridges or culverted road crossings, parking areas, building sites, or land fill which may or may not contain structures;
- Semi-impervious piers (i.e., slatted decking) that do not convey vehicular traffic. This would not include such things as wharfs at a port facility;
- Construction of an individual, single family residences, duplex, triplex, or quadruplex that are ~~is~~ not part of a larger plan of development;
- “Stand-alone” dredging, including maintenance dredging;
- Activities that do not add new impervious surfaces, such as the installation of overland and buried electric and communication transmission and distribution lines.

Only Applicant’s Handbook Volume I would apply to most of these activities because, unless specifically exempt, the above activities are still considered as types of stormwater management activities, and therefore are subject to regulation under Chapter 62-330, F.A.C.

This Volume provides specific, detailed information to meet the water quality and quantity design requirements of stormwater management systems. Such systems are regulated by the Suwannee River Water Management District through the ERP program authorized under s. 373.4145, F.S. This Volume explains, and provides more detail on, the rule criteria for stormwater quality and quantity contained in Chapter 62-330, F.A.C. In cases where conflicting or ambiguous interpretations of the information in this

Volume results in uncertainty, the final determination of appropriate procedures to be followed will be made using Chapters 120 and 373, F.S., and applicable F.A.C. rule chapters.

Both Applicant's Handbook Volumes I and II are adopted by reference in Chapter 62-330, F.A.C., and, as such, are rules of the Department and the District. The Handbooks are written to provide more detail and clarity to the public in understanding the statutory and rule provisions that implement the ERP program.

1.1.2 Criteria Objectives

The criteria contained herein were established with the primary goal of meeting District water resource objectives as set forth in Chapter 373, F.S. Performance criteria are used where possible. Other methods of meeting overall objectives and which meet the conditions for issuance set forth in Rules 62-330.301 and 62-330.302, F.A.C., will be considered. Compliance with the criteria herein constitutes a presumption that the project proposal is in conformance with the conditions for issuance set forth in Rules 62-330.301 and 62-330.302, F.A.C. Pursuant to Section 373.4131, F.S., if a stormwater management system is designed in accordance with the criteria in this Handbook or if a system is constructed operated, and maintained for stormwater treatment in accordance with a valid Environmental Resource Permit or exemption under Part IV of Chapter 373, the discharges from the system are presumed not to violate applicable state water quality standards.

1.1.3 Policy and Purpose

This Volume is intended to:

Prevent increase in existing flood hazards or damages by requiring that new development of water and related land resources:

1. Not restrict floodway conveyance through the use of fill or other obstruction;
2. Maintain pre-development rates of stormwater runoff and/or total volume of stormwater runoff as may be appropriate to the project and hydrologic conditions of the developed land;
3. Not reduce net storage volumes (including wetland, depressional, and soil storage volumes) within a project area; and
4. That new development which occurs in floodprone areas is made flood resistant to the greatest extent practical, or that development which cannot be made flood resistant is not permitted in floodprone areas.

Prevent pollution of waters by requiring control of post-development runoff from such areas to the extent necessary to insure minimum state water quality standards are met.

Preserve fish and wildlife by insuring that new development preserves or mitigates the conversion of water related habitats.

Prevent excessive drainage which will have an adverse impact on aquifer recharge or which would result in permanent conversion of wetlands to a non-wetland area.

Prevent the adverse alterations of drainage areas, watershed boundaries, and the interbasin transfers of surface water.

Further, it is the policy of the district that non-structural flood control methods are preferable to structural methods; and, therefore, it is the intent of the district not to support, sponsor, build, or otherwise initiate a structural public works flood control or drainage project intended to support new development; nor to assume maintenance or operational responsibility of such projects.

1.2 Thresholds

There are no additional Thresholds for this District.

1.3 Exemptions

Connections or additions to existing stormwater systems owned, operated, and maintained by a unit of local (city or county), regional, or state government if the connection or addition is authorized by the local unit of government under a local ordinance or by the unit or regional or state government under a license issued pursuant to Section 120.60, F.S., if

1. The authorization or license requires control of post development runoff rates and/or volumes in a manner consistent with the requirements of Rule 62-330, F.A.C.
2. Such connections or additions do not require alteration of the existing systems; and
3. Such connections or additions do not cause the existing system to become a hazard to the public health, safety or general welfare.

Construction, operation and maintenance of excavated ponds for single family, forestry, conservation, wildlife management or wildlife enhancement purposes that have less than 50 acre feet of storage capacity or are less than 5 acres in surface area if

1. The materials excavated remain on the property.
2. The excavated pond is not in wetlands or other surface waters
3. The excavated pond does not impound water above natural grade

PART II – GENERAL CRITERIA

2.1 Definitions and Acronyms

2.1 .1 Definitions

Additional Definitions can also be found in Applicant’s Handbook Volume I.

“100-Year Flood/One Percent Annual Chance of Flood” means that flood which has a one-percent probability of recurrence in any one year. The 100-year flood/one percent annual chance of flood elevation is the highest elevation of flood waters during the 100-year flood/one percent annual chance of flood and is calculated or estimated from the best available information. The 100-year flood/one percent annual chance of flood elevation shall not include coastal storm surge elevations unless such elevations have been developed in an approved Federal Emergency Management Agency Flood Insurance Study and such approved storm surge elevations have been accepted for implementation by the appropriate unit of local or state government.

“Base Flood Elevation” means the highest water surface elevation with a 1 percent chance of being equaled or exceeded in a given year.

“Closed Basin” means a watershed in which the runoff does not have a surface outfall up to and including the 100-year flood level.

“Closed System” means any reservoir or works located entirely within agricultural lands owned or controlled by the user and which requires water only for the filling, replenishing, and maintaining the water level thereof.

“Control Elevation” means the lowest elevation at which water can be released through the control device or withdrawn by a stormwater reuse system. This is sometimes referred to as the invert elevation.

“Control Structure (Control or Bleed-down Device)” means the element of a discharge structure which allows the gradual release of water under controlled conditions. Examples include orifices, notches, weirs, and effluent filtration systems.

“Critical Duration” means the length of the storm event that produces the largest difference between post development and pre development peak flow or volume without routing post-development hydrographs through a stormwater management system.

“Cut-off-Trench” means an excavation into the foundation material to accept an extension of the core.

“Detention Volume” means the volume of open surface storage behind the discharge structure measured between the overflow elevation and control elevation.

“Development” means any man-made change to improved or unimproved real estate within a work of the district including but not limited to, construction of surfacewater management systems, works, appurtenant works, structures, mining, dredging, filling, grading, paving, excavation, drilling operations, development of sewage disposal systems, or the alteration of the topography of a tract of land for purposes consistent with the occupation of agriculture, silviculture, floriculture, or horticulture including agricultural closed systems.

“Direct Hydrologic Connection” means a natural connection which occurs on an average of 30 or more consecutive days per year. In the absence of reliable hydrologic records, a continuum of naturally occurring wetlands may be used to establish a direct hydrologic connection.

“Discharge Structure” means a structural device, usually of concrete, metal, etc., through which water is discharged from a project to the receiving water.

“Earthen Dam” means a dam in which the principal barrier is an embankment of earth or rock fill or combination of earth and rock fill.

“Elevation” means the height in feet above mean sea level according to National Geodetic Vertical Datum or North American Vertical Datum.

“Emergency Spillway” means the spillway designed to convey excess water through, over, or around a dam.

“Emergency Spillway Hydrograph” means the hydrograph used to establish the dimensions of the emergency spillway.

“Floodway” or “Regulatory Floodway” means the channel of a river, stream, or other watercourse and adjacent land areas that must be reserved in order to discharge the 100-year flood/one percent annual change of flood without cumulatively increasing the 100-year flood/one percent annual chance of flood elevation more than a designated height. Unless otherwise noted, all regulatory floodways in the Suwannee River Water Management District provide for no more than one-foot rise in water surface elevations.

“Freeboard” means the height of the lowest point on the dam above the maximum design water level in the impoundment.

“Height of Dam” means the vertical distance as measured from the lowest elevation of the structure crest to the lowest point of natural ground, including any stream channel, along the downstream toe of the structure.

“Hydroperiod” means the duration of inundation in a wetland.

“Littoral Zone” means the portion of a wet detention or stormwater reuse pond which is designed to contain rooted aquatic plants.

“Minimum Rate of Flow” means the limit at which further withdrawals from a stream or other watercourse would be significantly harmful to water resources or ecology of the area.

“Normal Water Level” means the starting design water elevation used when determining stage/storage design computations in a retention or detention area. A retention or detention system may have two designated "normal water levels" associated with it if the system is designed for both water quality and water quantity.

“New Development” means any development which was not complete on the effective date of this chapter.

“Off-line Treatment System” means a system only for water quality treatment that collects project runoff and has no direct discharge capability other than percolation and evaporation. A system utilizing detention with effluent filtration is not an off-line treatment system.

“On-line Treatment System” means a dual purpose system that collects project runoff for both water quality and water quantity requirements. Water quality volumes are recovered through percolation and evaporation while water quantity volumes are recovered through a combination of percolation, evaporation, and surface discharge.

“Open Basin” means all watersheds not meeting the definition of a Closed Basin.

“Operation and Maintenance” means any activity or repair required to keep a stormwater management system functioning as permitted and designed.

“Overflow Elevation” means the design elevation of a discharge structure at or below which water is contained behind the structure, except for that which leaks or bleeds out, through a control device down to the control elevation.

“Permanent Pool” means the portion of a wet detention or stormwater reuse pond, which normally holds water, (e.g., between the normal water level and pond bottom), excluding any water volume claimed as wet detention treatment volume or stormwater reuse volume.

“Phreatic Surface” means the upper surface of the water table within the mass of the dam. It is the elevation of the water surface if an open hole were dug into the dam.

“Piping” means progressive erosion of soil within the dam, starting downstream and working upstream, creating a tunnel into the dam. Piping occurs when the velocity of the flow of seepage water is sufficient for the water to transport material from the embankment.

“Principal Spillway” means the lowest ungrated spillway designed to convey water from the reservoir at predetermined release rates.

“Regional Offsite Mitigation Areas” (ROMA) means environmental enhancement projects that serve as mitigation for multiple impact projects. Impact permit applicants pay money to the ROMA sponsor, and the collected funds are used toward the implementation of the larger mitigation project. ROMAs that serve as mitigation for more than 5 permits or 35 acres of impact are operated under a memorandum of agreement (MOA), similar to a mitigation bank permit.

“Registered Professional” means a professional registered or licensed by and in the State of Florida and practicing under Chapter 471, 472, 481, or 492, F.S.

“Rolled Dam” means a dam constructed of fill which is placed in layers which are mechanically compacted individually prior to placement of the next higher layer.

“Storage Capacity (of a dam)” means the volume of water impounded by the structure below the emergency spillway crest; or if no emergency spillway is used, the volume of water impounded below the top of the structure, less any freeboard.

“Tailwater Level (of a dam)” means the elevation of the water at the downstream toe of the dam.

“Toe (of a dam)” means the junction between the face of the dam and the adjacent terrain.

“Underdrain” means a drainage system installed beneath a stormwater holding area to improve the infiltration and percolation characteristics of the natural soil when permeability is restricted due to periodic high water table conditions or the presence of layers of fine textured soil below the bottom of the holding area. These systems usually consist of a system of interconnected below-ground conduits such as perforated pipe, which simultaneously limit the water table elevation and intercept, collect, and convey stormwater which has percolated through the soil.

“Uniform Mitigation Assessment Method” means the method to determine the amount of mitigation needed to offset adverse impacts to wetlands and other surface waters and to award and deduct mitigation bank credits.

“Wet Detention System” means a water quality treatment system that provides temporary storage of water in a permanently wet impoundment with subsequent gradual release of the stormwater. This system removes pollutants through settling, soil adsorption, and nutrient uptake by the vegetation.

“Works of the District” means those projects and works including, but not limited to, structures, impoundments, wells, streams, and other watercourses, together with the appurtenant facilities and accompanying lands, which have been officially adopted by the governing board as works of the district. Works of the District officially adopted by the board are adopted by rule in Rule 40B-4.3000, FAC.

2.1.2 Acronyms

List of Commonly Used Acronyms

Acronym	Definition
AMC	Antecedent Moisture Condition
BMP	Best Management Practice
CFR	Code of Federal Regulations
cfs	Cubic feet per second
District	Suwannee River Water Management District
ERP	Environmental Resource Permit
FAC	Florida Administrative Code
FDEP	Florida Department of Environmental Protection
FEMA	Federal Emergency Management Agency
FSE&SCIM	Florida Stormwater, Erosion & Sedimentation Control Inspector’s Manual
FWC	Florida Fish and Wildlife Conservation Commission
FS	Florida Statute
GPS	Global Positioning System
HSG	Hydrologic Soil Group
I/Ptotal	Intensity/Total Precipitation
MOA	Memorandum of Agreement
NA	Not applicable

NRCS	Natural Resources Conservation Service
NWL	Normal Water Line
OFW	Outstanding Florida Water
O&M	Operation and Maintenance
PMP	Probable Maximum Precipitation
P/Ptotal	Precipitation/Total Precipitation
ROMA	Regional Offsite Mitigation Areas
SHWL	Seasonal High Water Level
SRWMD	Suwannee River Water Management District
T	Time
UMAM	Uniform Mitigation Assessment Method
USFWS	United States Fish and Wildlife Service
USGS	United States Geological Survey
VNB	Vegetated Natural Buffer
WOD	Works of the District

2.2 Fees & Surety

2.2.1 Fees

A non-refundable permit processing fee as specified by section 40B-1.706, F.A.C., is required for the processing of each permit application or for a permit modification, and must be submitted concurrently with the filing of an application or the notice of intent. An application or notice submitted without the fee will not be considered complete.

2.2.2 Surety

Surety for certification of completion of construction shall be required as per Chapter 40B-1.704, F.A.C. for projects which propose new stormwater systems. Projects which propose to use existing systems or modify existing system will not require the surety. Projects which do not propose a stormwater system will not be required to provide the surety. Upon completion of the project in accordance with the permitted plans and specifications, submittal of the required as-built certification package and transfer of the permit to the operation and maintenance phase the bond will be released.

2.3 General Design and Performance Criteria

All activities shall meet and comply with the applicable requirements in Part II and VI of this Volume. Activities that require a stormwater management system under this Volume shall meet all the applicable requirements of Parts II, III and IV of this Volume. Design criteria can be found in Part V of the volume.

For the purposes of this District, the conditions in 62-330.301, F.A.C. are further explained as the following.

62-330.301(1)(a), F.A.C. The system or work will not cause excessive drainage of surface water or permanent dewatering of surficial aquifers.

62-330.301(1)(b), F.A.C. The system or work will not increase flood hazards outside the project area nor increase flood hazards which may affect the health, safety, and general welfare of persons residing within the project area.

62-330.301(1)(c), F.A.C. The system or work will not reduce surfacewater storage volumes within the project area.

62-330.301(1)(d), F.A.C. The system or work will have minimum adverse environmental impacts including impacts to fish, wildlife, wetlands, or other natural resources.

62-330.301(1)(e), F.A.C. Waters discharged or percolated from the system or work will receive a minimum level of stormwater treatment necessary to comply with appropriate state water quality standards.

62-330.301(1)(h), F.A.C. The new surfacewater management systems or individual works shall not facilitate development in a work of the district if such developments will have the potential of reducing floodway conveyance.

62-330.301(1)(j), F.A.C. The system or work will be maintained and operated in a manner consistent with the provisions in Applicant's Handbook Volume I and Part VI of this volume.

The district will not approve the issuance of permits for existing systems which are in violation of law or which have discharge to surface waters of the state that is in violation of a permit condition of any unit of local, state, or federal government or which presents an immediate danger to public health or safety.

The system or work will not cause erosion, and that any activities or land uses served by the system or work will not create erosion or sedimentation which may render the system unserviceable or degrade receiving waters;

The new surfacewater management systems or an individual work shall not utilize contiguous wetlands or dilution in waters of the state to achieve required stormwater treatment levels.

Finished floor elevations are required for all buildings. Buildings shall be elevated on piles such that the lowest structural member of the first floor is one foot above the 100-year flood elevation, or in the case of monolithic slab construction, the finished slab elevation shall be one foot above the 100-year flood elevation;

Roads with public access must be constructed and laid out in conformance with the minimum standards of local government. In the absence of local government standards for roads and associated surfacewater management systems, the following minimum standards shall apply:

1. Driving surface shall be stabilized soil, according to the latest edition of the Florida Standard Specification for Road and Bridge Construction.
2. Two driving lanes with a minimum driving surface of 16 feet.
3. Driving surface shall be sloped to drain at a minimum of 2 percent (2%).
4. Culverts shall be used to maintain pre-development drainage patterns up to the 10-year, 24-hour storm event.
5. Swales shall be used for water quality treatment with a maximum slope of three-to-one (3:1) and erosion shall be controlled with grass or other equivalent method.

All storage volumes in detention or retention systems shall be calculated so as not to include any volumes below the average seasonal high water table for the project area.

Surfacewater management systems must not alter contributing areas or watershed boundaries of any watershed or basin not wholly contained within the project area.

There must be no reduction of floodway conveyance within the project area.

Systems serving a use that produces or stores hazardous or toxic substances shall be designed to have no stormwater discharge that contains such substances.

Stagnant water conditions such as hydraulically dead end canals are to be avoided, regardless of the type of development.

Legal authorization, such as an easement, deed restrictions, or other instrument must be provided establishing a right-of-way or access for maintenance of the stormwater management system unless the operation and maintenance entity wholly owns or retains ownership of the property. The following are requirements for specific types of maintenance access easements:

1. Easements must cover at least the primary and high maintenance components of the system (i.e., inlets, outlets, littoral zones, filters, pumps, etc.), including provisions for equipment to enter and perform the necessary maintenance on the system. Applicants may propose site- specific easements that meet this requirement.
2. Easements for water bodies, open conveyance systems, stormwater basins, and storage areas that:
 - Include the area of the water surface measured at the top of the pond and at the control elevation;
 - Are traversable by maintenance equipment.
3. Access easements must be 20 feet wide from a public road or public right- of-way to the stormwater management system.

Applicants who propose to use offsite areas that are not under their ownership or control must obtain sufficient legal authorization prior to permit issuance to use the area in order to satisfy the requirements for issuance specified in 62-330, F.A.C. Applicant's Handbook Volume I or this Volume. Any alteration to stormwater discharges to adjacent properties resulting from permitted activities, such as increase of flow or change of discharge location, also requires appropriate legal authorization. A copy of the legal authorization must be submitted with the permit application.

As part of the determination as to whether a dam meets the criteria in Rule 62-330.301, F.A.C., and this section, a dam over five feet in height (as measured from the crest of the dam to the lowest elevation on the downstream toe) with the potential to store 50 acre feet or more of water, and any dam 10 feet or more in height must be designed, constructed, operated, and maintained consistent with generally accepted engineering practice as applied to local conditions, considering such factors as: the type of materials used to construct the dam, the type of soils and degree of compaction, hydrologic capacity, construction techniques, and hazard rating. A document that provides useful information for this purpose is *Design of Small Dams*, U.S Department of Interior, Bureau of Reclamation, Third Edition, 2006.

2.3.1 Pre-application Conference

Pre-application meetings are encouraged. The purpose of a pre-application meeting is to identify issues that need to be addressed in detail such as:

1. Application completion, processing, and evaluation procedures;
2. Information that will be required for evaluation of the application;
3. Information regarding surface water data that is known to be available at that time;
4. The criteria that will be used to evaluate the application; and
5. Other hydrologic, environmental, or water quality data that may be needed to evaluate the application.

Pre-application meetings assist the applicant to submit a complete application. Information provided during a pre-application meeting is considered preliminary and not part of the formal application process, thus are not binding on the District.

To receive the maximum benefit from the pre-application conference, the applicant should bring as much of the following information as they have to the meeting. It is not necessary to bring all of the following information, but the more specific the information at the start of the meeting, the more specific the results will be. Useful information includes:

- Geographic references such as section, township, range and parcel identification number;
- An overview map displaying the section, township, range and project location or parcel identification number and/or a detailed map (acceptable maps include tract maps, parcel maps, plats or similar construction drawings, or aerial photography at the plat-tract map scale);
- Aerial photograph at scale suitable for photo-interpretation of wetlands or other surface waters with ownership and project area outlined;
- The total land area, project area and land survey;
- Existing and proposed topography (grading) showing the existing and proposed flow patterns;
- The location of any on site or adjacent wetlands and other surface waters;
- Wildlife survey, if appropriate;
- The location and details of the existing and proposed surface water management system;
- A brief narrative describing the proposed construction activity;
- Construction drawings to illustrate the proposed activities;
- The history behind any existing permits that directly relate to the project or may be affected by the project;
- Differentiate between contiguous ownership and property served by proposed activity, and if single activity or phased construction;
- Location of impervious surfaces (i.e. buildings, parking areas, etc.), the amount of proposed impervious area and the amount of impervious area to be removed;
- Location of activities that may increase pollutant loading and adversely affect water quality (both surface and ground):
- Information on proposed stormwater management system design concepts such as: wet detention, dry retention, on-line, off-line, culverts, etc;
- Soils information;
- FEMA flood hazard map, if in approximate area, how to establish an existing floodplain elevation;
- FEMA flood insurance study if a designated floodway is involved;
- Any existing or preliminary analyses (modeling);
- Erosion and sediment control plan;
- Operation and maintenance plan;
- Water and sewerage service for the project;
- Compliance or enforcement; and
- Bonding, letter of credit or other type of surety requirements for as-built certifications.

To schedule a pre-application conference, potential applicants should contact the District office.

2.4 Professional Certification

All construction plans and supporting calculations submitted to the District for storm water management systems that require the services of the registered professional must be signed, sealed, and dated by a registered professional. "Registered Professional" means a professional registered or licensed by and in the State of Florida and who possesses the expertise and experience necessary for the competent preparation, submittal and certification of documents and materials, and performing other services required in support of permitting, constructing, altering, inspecting, and operating a proposed or existing activity regulated under Part IV of Chapter 373, F.S. Examples of registered professionals, authorized pursuant to Chapter 455, F.S., and the respective practice acts by which they are regulated, are professional engineers licensed under Chapter 471, F.S., registered landscape architects registered under Chapter 481, F.S., professional surveyors and mappers under Chapter 472, F.S., and professional geologists licensed under Chapter 492, F.S.

2.5 Surveys

All survey data to be submitted shall be signed and sealed by the appropriate registered professional. The survey shall include township, range and section, parcel information including parcel number and legal descriptions, temporary and permanent benchmarks, boundary information, topographic contours, all existing easements, setbacks, existing structures, FEMA flood zones with corresponding flood elevation information, location of water, sewer, reuse, gas and power lines, the location of all natural formations such as wetlands, sink holes, ponds, lakes, creeks, and streams.

2.6 Computer models

The district does not have a specified list of computer models that must be used. Any model used must be able to provide the reasonable assurance that is required for issuance. District staff will use common models or if available the model the design professional used in order to review the results. If the model the design professional used is not available to the district reviewer, the results from available models must be similar.

2.7 Flexibility for State Transportation Projects and Facilities

With regard to state linear transportation projects and facilities, the Agencies shall be governed by subsection 373.413(6), F.S. (2012).

2.8 Redevelopments and Retrofits of Existing Surface Water Management Systems

A stormwater retrofit project is typically proposed by a county, municipality, state agency, or water management district to provide new or additional treatment or attenuation capacity, or improved flood control to an existing stormwater management system or systems. Stormwater retrofit projects shall not be proposed or implemented for the purpose of providing the water quality treatment or flood control needed to serve new development or redevelopment.

Examples of stormwater retrofit projects are:

1. Construction or alteration that will add additional treatment or attenuation capacity and capability to an existing stormwater management system;
2. Modification, reconstruction, or relocation of an existing stormwater management system or stormwater discharge facility;

3. Stabilization of eroding banks through measures such as adding attenuation capacity to reduce flow velocities, planting of sod or other vegetation, and installation of rip rap boulders;
4. Excavation or dredging of sediments or other pollutants that have accumulated as a result of stormwater runoff and stormwater discharges.

The applicant for a stormwater quality retrofit project must provide reasonable assurance that the retrofit project itself will, at a minimum provide additional water quality treatment such that there is a net reduction of the stormwater pollutant loading into receiving waters.

Examples of stormwater quality projects are:

1. Addition of treatment capacity to an existing stormwater management system such that it reduces stormwater pollutant loadings to receiving waters;
2. Adding treatment or attenuation capability to an existing developed area when either the existing stormwater management system or the developed area has substandard stormwater treatment and attenuation capabilities, compared to what would be required for a new system requiring a permit under Part IV of Chapter 373, F.S.; or
3. Removing pollutants generated by, or resulting from, previous stormwater discharges.

If the applicant has conducted, and the Agency has approved, an analysis that provides reasonable assurance that the proposed stormwater quality retrofit will provide the intended pollutant load reduction from the existing system or systems, the project will be presumed to comply with the requirements in section 4 of this Volume.

The pollutants of concern will be determined on a case-by-case basis during the permit application review based upon factors such as the type and intensity of land use, existing water quality data within the area subject to the retrofit, and the degree of impairment or water quality violations in the receiving waters.

The applicant for a stormwater quantity retrofit project must provide reasonable assurance that the retrofit project will reduce existing flooding problems in such a way that it does not cause any of the following:

1. A net reduction in water quality treatment provided by the existing stormwater management system or systems;
2. Increased discharges of untreated stormwater entering adjacent or receiving waters;

If the applicant has conducted, and the Agency has approved, an analysis that provides reasonable assurance that the stormwater quantity retrofit project will comply with the above, the project will be presumed to comply with the requirements in section 3 of this Volume.

The applicant for any stormwater retrofit project must design, implement, and operate the project so that it:

1. Will not cause or contribute to a water quality violation;
2. Does not reduce stormwater treatment capacity or increase discharges of untreated stormwater. Where existing ambient water quality does not meet water quality standards the applicant must demonstrate that the proposed activities will not cause or contribute to a water quality violation. If the proposed activities will contribute to the existing violation, measures shall be proposed that will provide a net improvement of the water quality in the receiving waters for those parameters that do not meet standards.
3. Does not cause any adverse water quality impacts in receiving waters; or

4. Will not cause or contribute to increased flooding of adjacent lands or cause new adverse water quantity impacts to receiving waters.

PART III – STORMWATER QUANTITY / FLOOD CONTROL

3.1 General

This document refers, in common engineering language, to flood and drought frequency impacts interchangeably with rainfall frequency. Additional calculations may be required to identify other combinations of site conditions and rainfall frequencies which might result in impacts of the specified frequency. Examples include designs affected by spring tides, fluctuating tides and fluctuating receiving water stages.

An applicant for an ERP permit must provide mitigation for changes to water quantity such that these changes do not cause harm to individuals or water resources. The most widely used form of mitigation is the construction of stormwater management systems. Most systems are a combination of a retention and detention system. However, it is common practice to term a system exclusively retention or detention dependent upon its main function. Thus, a system whose volume is mostly in the form of retention would be called a retention system and likewise for a detention system.

These measures are not the only acceptable forms of mitigation. An applicant may wish to propose other alternatives, such as acquisition of flood rights or compensation for anticipated damages.

3.1.1 Factors Influencing Water Quantity

Water quantity can be measured in terms of volume and rate. The volume of runoff will be increased by any one of the following factors:

1. Vegetation removal;
2. Elimination of natural depressional storage;
3. Soil compaction;
4. Placement of impervious surfaces over pervious surfaces; or
5. Ditching.

The rate of runoff is a function of volume and time. The discharge rate increases if runoff volume is increased, by the factors listed above, and/or the time of concentration is decreased. The time of concentration decreases if a channelization effect is incurred, such as converting overland sheet flow to ditch flow or converting ditch flow to storm sewer flow. The net effect of these activities is to increase flow velocity, thereby decreasing time of concentration

3.1.2 Antecedent Moisture Condition

AMC refers to the amount of moisture and storage in the soil profile prior to a storm event. Antecedent soil moisture is an indicator of wetness and availability of soil to infiltrate water. The AMC can vary from dry to saturated depending on the amount of rainfall received prior to a given point in time. Therefore, “average AMC” means the soil is neither dry nor saturated, but at an average moisture condition at the beginning of a storm event when calculating recovery times.

The antecedent condition has a significant effect on runoff rate, runoff volume, infiltration rate, and infiltration volume. The infiltration volume is also known as the upper soil zone storage. Both the infiltration rate and upper soil zone storage are used to calculate the recovery time of retention systems and must be estimated using any generally accepted and well documented method with appropriate parameters consistent with such generally accepted and well documented method to reflect drainage practices, SHWL, the AMC, and any underlying soil characteristics which would limit or prevent percolation of storm water into the soil column.

3.2 Design Storms

For projects which serve exclusively agricultural, forest, conservation, or recreational land uses, a design storm with a 10-year, 24-hour rainfall depth with SCS type II distribution falling on average antecedent moisture conditions shall be used.

For projects which serve all other land uses, a design storm with 100-year critical duration rainfall depth with SCS type II distribution falling on average antecedent moisture conditions shall be used.

The District requires specific storm events to be analyzed in order to determine the storm of critical duration. The storm frequency (return period) is the probability that a storm depth would be equaled or exceeded in a given period of time. The relationship between design storm frequency and duration and rainfall distribution data is provided in the Appendix. The applicant shall analyze the 100-year frequency (one percent annual chance) analysis of the 1-, 2-, 4-, 8-, 24-hour, 3-, 7-, and 10 day durations for all stormwater systems.

3.3 Discharge rates and volumes

For projects which fall within a coastal, stream, or open-lake watershed, retention or detention systems may be utilized. For these systems, the post-developed peak discharge rate must not exceed the pre-developed peak discharge rate for any event. The discharge structure of the system shall be designed to provide for the release of water at rates similar to pre-development conditions for storm events up through and including the design storm.

For projects which fall within an internally drained, stream to sink or closed-lake watershed retention systems shall be utilized. For these systems, the post-developed peak discharge rate and volume must not exceed the pre-developed peak discharge rate and volume for any event. The discharge structure of the system shall be designed to provide for the release of water at rates similar to pre-development conditions for storm events up through and including the design storm. The required retention volume is the post-developed runoff volume less the pre-developed runoff volume for the 100-year critical event with a maximum duration of 10 days.

Where multiple off-site discharges are designed to occur and the combined discharges outfall to the same receiving water body, the District will not allow the total post-development peak discharge to exceed the pre-development peak discharge for the combined discharges.

3.3.1 Methodologies for Calculating Discharge

There are several equations available for calculating discharge including, but not limited to, the Rational Method, Natural Resources Conservation Service (NRCS) method, and USGS regression equations.

A peak discharge analysis typically consists of generating pre-development and post-development runoff hydrographs, routing the post-development hydrograph through a detention or retention basin, and sizing an overflow structure to control post-development discharges at or below pre-development discharge. Acceptable design techniques also include the use of grassed waterways, and any other storage capability that the particular system may have.

Peak discharge computations shall consider the duration, frequency, and intensity of rainfall, the antecedent moisture conditions, upper soil zone and surface storage, time of concentration, tailwater conditions, changes in land use or land cover, and any other changes in topographic and hydrologic

characteristics. Large systems should be divided into sub-basins according to artificial or natural drainage divides to allow for more accurate hydrologic simulations.

The Peak Rate Factor reflects the effect of watershed storage on the hydrograph shape and directly and significantly impacts the peak discharge value. As such, K' must be based on the true watershed storage of runoff, and not on the slope of the landscape which is more accurately accounted for in the time of concentration. However, the average slope of natural watersheds is highly interrelated with the surface storage potential. Land development will generally result in a reduction of natural storage. As a result, the K' value should either increase or remain constant, but never decrease. In most cases, post-development conditions will include detention storage areas; this storage should be accounted for by routing the hydrograph based on a defined stage-storage-discharge relationship and should therefore not be considered in determining K' . The most conservative approach is to use a $K' = 484$ for post-development.

3.4 Recovery

Storage volumes designed into retention or detention systems must be available as follows:

1. One-half of the total volume within seven days following the end of the design storm event, and
2. The total volume within 30 days following the end of the design storm event.

For retention systems, only percolation and evapotranspiration may be used to reduce storage volumes in the system.

Since the stormwater must receive at least the minimum amount of water quality treatment before discharge, detention systems with a bleed down pipe at the bottom of the pond are not permissible. For detention systems with filtration, the design must accommodate a safety factor of two which can be accomplished by increasing storage volumes, or reducing the percolation rates. Further, filters and filtration systems must have pore spaces large enough to provide a minimum permeability equal to or greater than the soil surrounding the filter. The filter medium must be stable and not move. If sand or other fine textured medium is used, it must meet the following characteristics:

1. Have less than one percent silt, clay, or organic matter unless filter fabric which will retain the fines is also used;
2. Have a uniformity coefficient of 1.5 or greater; and
3. Have an effective grain size of 0.20 to 0.55 millimeters in diameter.

These criteria are not intended to preclude the use of multilayered filters nor the use of additives to increase ion exchange, precipitation, or pollutant adsorption capacities of the filter.

In the event that a stormwater pond cannot meet the requirements above, the design professional may route back to back storms through the system. The system must be able to provide for required discharge rates and volumes.

3.4.1 Percolation and Water Table

Percolation outflow is a function of site specific conditions such as soil density, particle size, degree of saturation, and water table. The recovery of the system depends on this information. Therefore, determining the percolation outflow is extremely important and can be very difficult. Percolation tests shall be performed or supervised by the appropriate registered professional. The location of soil borings and percolation test should be in the proposed location of the retention or detention pond. There shall be at least one boring per acre of the retention or detention pond. Boring should be spread out within the proposed area in order to obtain a reliable sampling.

Water table elevations will affect percolation rates. The design professional must consider seasonal high ground water table (SHGWT) at the site to accurately determine percolation rates. Where the SHGWT is at different elevations within the proposed location of the detention or retention pond, the average of the highest and lowest SHGWT shall be used. SHGWT must be determined by on-site soil investigation by the appropriate registered professional.

Other information, such as, but not limited to, base of aquifer, fillable porosity, and horizontal conductivity shall also be provided by the appropriate registered professional. A soils report, which should include information from any documents about the soil such as the NRCS soil reports and any information found through testing of the specific soils, should be signed and sealed by the appropriate registered professional. Soil borings which support the determination are required.

3.4.2 Mounding

In addition to the water table, mounding will affect the percolation rate. For retention ponds, a computer model that incorporates a mounding analysis must be used. The mounding analysis is not required for detention ponds.

3.5 Compensating Stormwater Treatment

Applicants may find that it is impractical to construct a stormwater management system to capture the runoff from a portion of the project site as a result of on-site conditions such as extreme physical limitations, availability of right-of-way, or maintenance access. One method is to provide treatment for an off-site area which currently is not being treated (i.e., "off-site compensation"). Each method is designed to furnish the same level of treatment as if the runoff from the entire project site was captured and treated in accordance with the provisions of this Guide.

The applicant is strongly encouraged to schedule a pre-application conference with District staff to discuss the project if this alternative is being considered. Other rule criterion, such as peak discharge attenuation, will still have to be met if the applicant uses this method.

3.6 Floodplain Delineation

District requires that the applicant's engineer will determine and provide the one percent annual chance of flood elevation as part of the required information for any development in or around areas subject to flooding. These elevations should be determined using one of the following sources:

- Historical gaged data;
- Detailed flood study with a current, effective model;
- Federal Emergency Management Agency (FEMA) flood insurance rate maps and flood insurance studies that have an established base flood elevation; or
- Calculations that are based on an acceptable hydrologic and hydraulic methodology.

Floodplain areas occur as static or dynamic systems. Static floodplain areas consist of runoff entrapped and held in surface bodies such as ponds, swamps, lakes, and topographical depressions. Outflow from a static floodplain area occurs through natural percolation and/or evapotranspiration. Dynamic floodplain (or floodway) areas occur in riverine systems.

3.6.1 Static Systems

The floodplain elevation for a static system is determined using a flood routing calculation similar to the one used in design of a retention facility. If percolation is available, a critical duration analysis must be performed. The floodplain elevation will be the highest elevation calculated for the various durations. For some static systems such as large lakes and complex lake chain systems, it is extremely difficult if not impossible to perform an accurate analysis. For these situations, historical information should be sought from local residents or government officials.

3.6.2 Floodplain Storage and Conveyance

A project may not:

1. Reduce existing surfacewater storage and conveyance capabilities;
2. Cause adverse water quantity impacts to receiving waters and adjacent lands;
3. Increase flood hazards outside the project area; or
4. Increase flood hazards that may affect the health, safety, and general welfare of persons residing within the project area.

There must be no net decrease in storage volume below the one percent annual chance of flood elevation within the project area which may result in increased flood hazards. The District will consider reductions due to filling, soil compaction, or covering with impervious surface in determining loss of storage and any increase in flood hazard. Floodways and floodplains, and levels of flood flows or velocities of adjacent streams, impoundments, or other water courses must not be altered so as to adversely impact the off-site storage and conveyance capabilities of the water resource. Buildings must be elevated on piles such that the lowest structural member of the first floor is one foot above the 100-year flood elevation, or in the case of monolithic slab construction, the finished slab elevation shall be one foot above the 100-year flood elevation.

3.6.3 Importer/Exporter (Site Storage Capacity)

Project areas which import runoff before development must continue to do so after development. Project areas which export runoff prior to development may continue to do so. The post development export of runoff must meet the appropriate rate and or volume criteria as well as approximate the type of export (for example, pre-developed sheet flow exporting should be approximated in the post-developed condition).

3.6.4 Compensating Storage

Compensating storage may be used in order to accomplish no net increase in flood elevations. Compensating volumes shall be above the seasonal high ground water table and shall, at a minimum, have a 1:1 ratio of volume provided to volume displaced. The volume below the maximum stage in the retention pond may not serve or contribute to the compensating volume.

3.6.5 Dynamic Systems

Floodplain elevations for dynamic systems (floodways) can be calculated using a generally accepted hydrologic and hydraulic modeling technique. This approach provides reliable data and is only superseded by historical gage information in accuracy.

3.6.6 “No-Rise” Requirements for Floodways

For any structure placed within a floodway, including a Work of the District, a Florida licensed engineer shall certify that such structure will not obstruct flows or increase the one percent annual chance of flood

elevations by more than 0.01 feet. Certification shall include step-backwater calculations using the one percent annual chance of flood discharge rate.

A generalized method for determining “no-rise certification” may include the steps below. All model runs shall be in the floodplain (“without floodway”) conditions.

1. Obtain the current effective District model.
2. Run the current effective model. Your results must match that of the current effective model.
3. Add the pre-development cross-sections of channel and overbank geometry (without proposed floodway encroachment). Run the model with pre-development cross-sections. Your results must match that of the current effective model.
4. Run the model with the existing, permitted and proposed floodway encroachments.
5. The water surface profile obtained in paragraph 4. above should be no greater than the water surface profile obtained in paragraph 3. above by no greater than 0.01 feet.

The engineer shall submit a report demonstrating a systematic analysis that provides evidence that the proposed project will produce no rise in flood profile or base flood elevations. The report should document an analytical process similar to the preceding method.

3.7 Determination of Tailwater Conditions

The applicant must determine the design discharge rate, 100-year discharge rate, and corresponding tailwater elevations prior to selecting a culvert configuration. The tailwater elevations are the water surface elevations in the receiving watercourse at the culvert outlet corresponding to the discharge rates.

The discharge rate is established using any acceptable hydrologic methodology. Typically, for small watersheds (i.e., less than 200 acres), the Rational Method is acceptable. For larger watersheds, a Regression Analysis as discussed above should be used. Generally, the NRCS methods should not be used since they may not produce a critical design situation. The District does not specify a design frequency to be used since the frequency may vary depending on specific site conditions and other constraints. However, the design frequency and corresponding hydraulic data must be provided in addition to analyzing the structure under 100-year frequency conditions.

The tailwater elevation for the design discharge rate can be obtained by computing the water profile corresponding to the design rate as discussed above. However, if a computer model is not employed, an approximation may be used by solving Manning’s equation using the design discharge rate and the friction slope corresponding to the 100-year profile and 10-year frequency.

If the project is bounded by natural watercourses, a water surface profile analysis, as discussed above, will automatically provide the tailwater elevation for the 100-year discharge rate.

If the project area discharges to man-made ditches and channels with a uniform cross section and slope, the slope of the energy line is parallel to the water surface and channel bottom. Thus, the tailwater depth is determined using Manning’s equation and the physical slope of the channel bottom.

3.7.1 Topographical Information

Cross-section information is required for the reach of the system to be modeled. A minimum of four cross sections should be taken. In addition, all channel bends and constrictions should have cross sections. Cross sections should be taken perpendicular to the flow of the waterbody. The initial cross section should be located some distance downstream of the area to be modeled. The distance between successive cross sections must also be determined as depicted below:

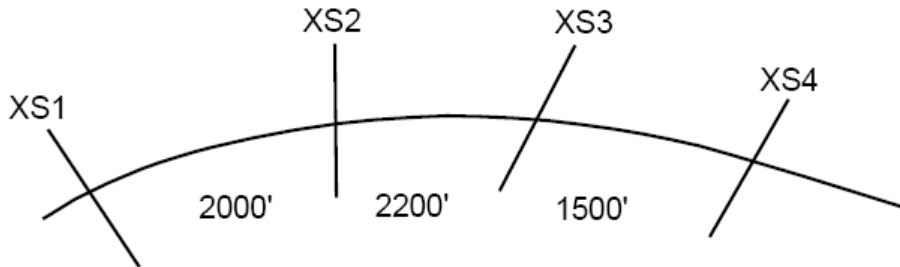

Cross sections should be taken from left to right looking downstream and proceed upstream. Required information includes beginning station and elevation with successive elevations and stations being recorded at each break not to exceed intervals of 200 feet. Manning's "n" values should also be selected in the field and noted on the cross section. Manning's "n" values should change to reflect differences in resistance to flow such as trees, limbs, brush, meandering channel, etc. A typical cross section with required field information is depicted in below:

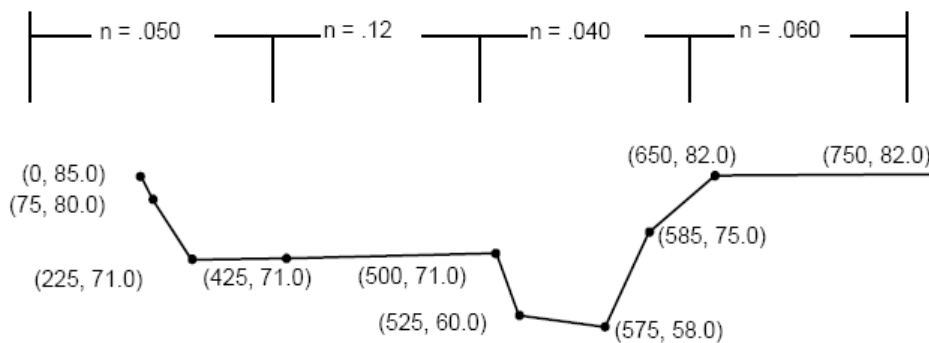

3.7.2 Surface Profile

Prior to calculating the water surface profile, the information outlined in the previous sections must be obtained.

The next step is to calculate the boundary properties for each cross section at various elevations. The elevation interval selected should be commensurate with the accuracy desired. A minimum accuracy of one-foot elevations is required. Therefore, boundary properties should be determined at one-half foot increments. Required cross section properties include area, wetted perimeter, and hydraulic radius.

Once this data has been generated, the calculation of the water surface profile begins. The water surface elevation of successive cross sections is achieved by solving the one-dimensional energy equation as it applies to natural watercourses. The energy equation relationships are graphically depicted below:

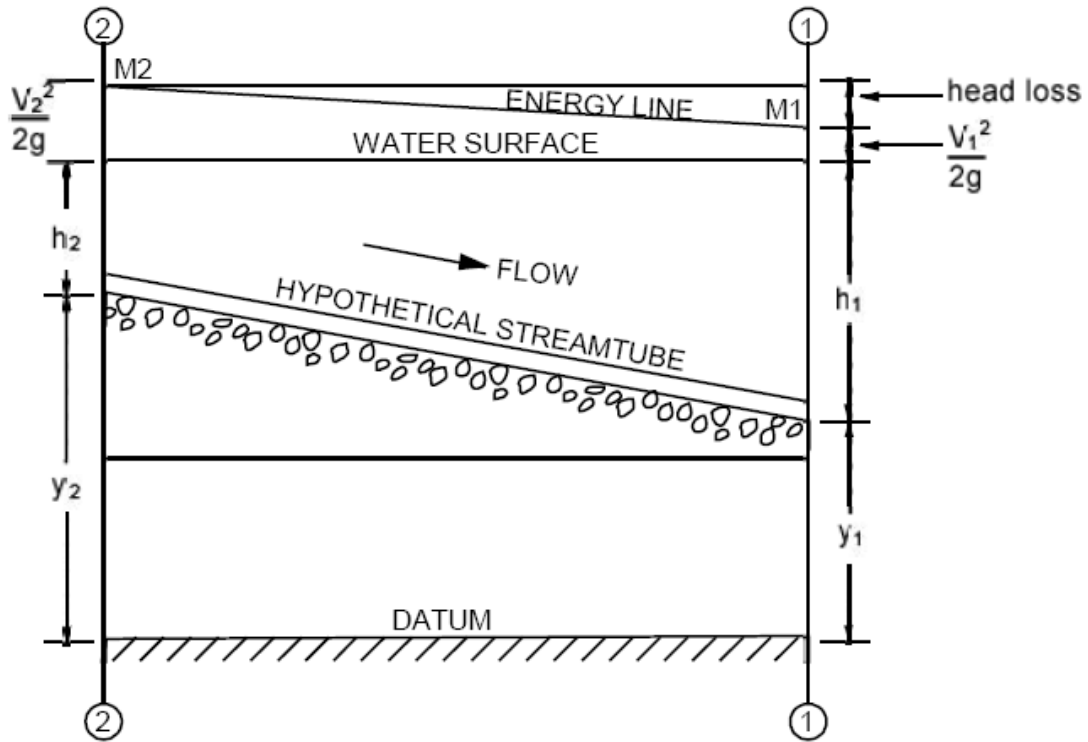

3.8 Low flow and Base Flow Maintenance

Proposed systems shall not decrease the flows of adjacent streams, impoundments or other watercourses below any minimum level or flow established by a water management district Governing Board pursuant to Section 373.042, FS.

PART IV – STORMWATER QUALITY

4.1 General

An applicant for individual or general permit must provide mitigation for changes to water quality such that these changes do not cause harm to individuals or water resources. The most widely used form of mitigation is the construction of stormwater management systems. Most systems are a combination of a retention and detention system. However, it is common practice to term a system exclusively retention or detention dependent upon its main function. Thus, a system whose volume is mostly in the form of retention volume would be called a retention system and likewise for a detention system.

All new drainage projects will be evaluated based on the ability of the system to prevent degradation of receiving waters and the ability to conform to State water quality standards.

Water quality impacts are typically mitigated by providing treatment of initial runoff volume. This initial volume sometimes called “first-flush” carries a high percentage of the generated pollutants.

Alternate methodologies for water quality treatment shall be considered.

4.1.1 Factors Influencing Water Quality

Water quality degradation can be attributed to the following activities:

- Placing impervious surfaces that no longer allow surface water to percolate and filter through permeable soils;
- Eliminating natural water quality enhancement systems such as wetlands;
- Increasing erosion potential and thereby sedimentation, from either vegetation removal and/or increased flow velocity; and
- Creating point-source pollutant generators such as vehicles, service stations, and industrial processes.

4.2 Dewatering

This District does not have a dewatering permit. If dewatering is required, it shall be address in the review and issuance of the ERP. Dewatering plans may be designed by a registered professional to be the minimum required to provide and meet water quality standards. During the pre-construction conference, or during the dewatering process, if the contractor, find that the plans in not sufficient to provide the required treatment, the contractor is required to upgrade the plan.

4.3 State water quality Standards

All storm water management systems must be designed to provide minimum state water quality treatment requirements. Stormwater can be treated by percolation, evapotranspiration, detention with filtration, or other means to conform with the post-development runoff volumes listed below, whichever is less:

1. If any part of the project area is in a stream-to-sink watershed and the stormwater can be reasonably expected to be free of hazardous or toxic substances, the minimum stormwater treatment volume shall be the runoff from the first 2.0 inches of rainfall from the design storm;
2. If the project area falls within a stream, coastal, or open-lake watershed and the discharge is to an Outstanding Florida Water, the minimum stormwater treatment volume shall be the runoff from the first 1.5 inches of rainfall from the design storm; or
3. If the project area falls within a stream, coastal, or open-lake watershed and the discharge is to any class of surface water other than an Outstanding Florida Water, the minimum stormwater treatment volume shall be the runoff from the first 1.0 inch of rainfall from the design storm.

Only the minimum criteria apply within a zone of discharge. A zone of discharge is defined as a volume underlying or surrounding the site and extending to the base of a specifically designated aquifer or aquifers, within which an opportunity for the treatment, mixture or dispersion of wastes into receiving ground water is afforded. Generally, stormwater systems have a zone of discharge 100 feet from the system boundary or to the project's property boundary, whichever is less.

Stormwater retention and detention systems are classified as moderate sanitary hazards with respect to public and private drinking water wells. Stormwater treatment facilities shall not be constructed within 100 feet of a public drinking water well, and shall not be constructed within 75 feet of a private drinking water well.

4.4 Recovery

Detention and retention systems must be designed to provide treatment volumes specified above within 72 hours following the end of the design storm event. For retention systems, only percolation and evapotranspiration may be used to reduce storage and treatment volumes in the system. If detention with filtration is proposed, the design must accommodate a safety factor of two which can be accomplished by increasing storage volumes, providing specified treatment volumes within 36 hours, or other means.

It is recommended that the treatment volume is simulated as a slug load the computer model

4.5 Erosion Control and Stabilization

The potential for soil erosion is greatly increased when development occurs. This is attributed to stripping of vegetation, land clearing activities, increased runoff volumes and rates, and concentration of surface runoff. The District requires that measures be taken to minimize soil erosion and sediment transport. BMPs from the FSE&SCIM should be designed, constructed, and maintained consistent with the FSE&SCIM such that at all times, erosion and sedimentation from the system, including the areas served by the system, do not cause violations of applicable state water quality standards in receiving waters. Further, because sedimentation of offsite lands can lead to public safety concerns, erosion and sediment controls shall be designed and implemented to retain sediment on-site. In particular, the erosion and sediment control requirements described in the Applicant's Handbook Volume I shall be followed during construction of the system.

4.5.1 Side Slopes

Side slopes shall be designed with a horizontal to vertical ratio no steeper than 4:1 to a depth at least two feet below the control elevation and must be stabilized with vegetation to prevent erosion and provide pollutant removal.

Side slopes may be designed with steeper than 4:1 side slopes provided the slopes have adequate temporary and permanent erosion and sediment control BMPs. Systems may be fenced if the slopes must be steeper than 4:1 due to space limitations or other constraints.

4.6 pollutant control

4.6.1 Pre Treatment

“Pre-treatment” is considered the treatment of a portion of the runoff prior to its entering the stormwater pond. Pre-treatment increases the pollutant removal efficiency of the overall stormwater system by reducing the pollutant loading to the stormwater pond. Pre-treatment may be used to enhance the appearance of the stormwater pond or meet the additional treatment criteria for discharges to receiving water which are classified as OFWs.

For developments where the appearance of the lake is important, pre-treatment can reduce the chances of algal blooms and slow the eutrophication process. Some types of pre-treatment practices include utilizing vegetative swales for conveyance instead of curb and gutter, perimeter swales or berms around the lake, oil and grease skimmers on inlet structures, retention storage in swales with raised inlets, or shallow landscaped retention areas (when soils and water table conditions will allow for adequate percolation).

4.6.2 Oil and Grease Control

Oils, greases, and other floatables may exit through control structures when the retention volume is exceeded. Therefore, the District requires that design systems include preventative measures under the following circumstances:

1. More than 50 percent of the project area is impervious surfaces;
2. More than two acres of the project area are impervious surfaces;
3. Runoff is discharged directly from paved areas; or if
4. The installation requires a baffle/skimmer/trap due to the nature of and frequency of oil or grease products used on the site, regardless of its size.

To prevent oil and grease from exiting the basin, skimmers or baffles shall be used. Other methods may be used if they can be proven to remove the oils and greases. Examples of a skimmer and baffle are below:

Skimmer

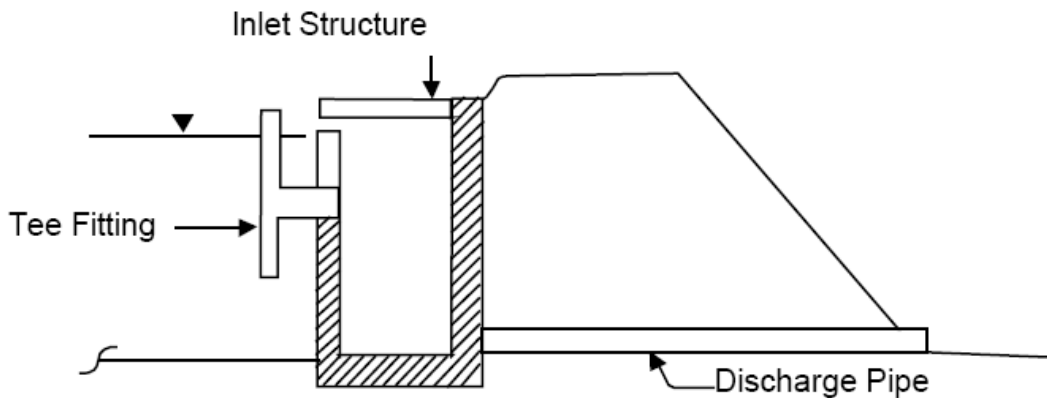

Baffle

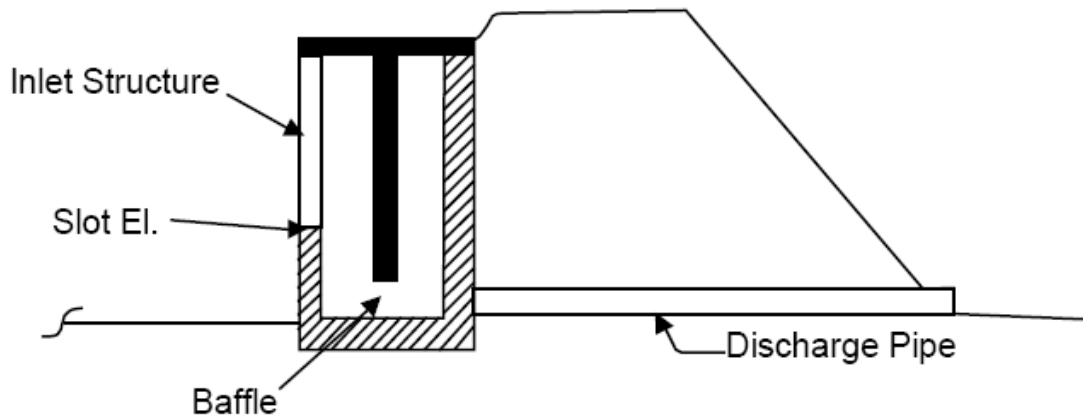

4.7 Runoff coefficients and curve numbers for stormwater systems.

Stormwater management ponds, including dry retention ponds, detention ponds with filtration, dry detention ponds with underdrains, and wet detention ponds, shall be considered as 100% impervious. The area, calculated from the top of the pond, shall be directly connected impervious areas in calculating composite runoff coefficients (C), and composite curve numbers (CN). Pervious pavement, pavers and other such surfaces shall use the runoff coefficient as the below ground. Compacted limerock or clay and millings shall be considered semi impervious.

PART V -- BEST MANAGEMENT PRACTICES

The Best Management Practices (BMP)s below are the most frequently used BMPs in this district. The criteria listed below are those that, if followed, will result in reasonable assurance that the BMP will meet the conditions of issuance. An applicant may propose alternative designs to those provided in this Section for consideration by the District. However, reasonable assurance in the form of plans, test results, or other information must be provided by the applicant to demonstrate that the alternative design meets the conditions for issuance in Rule 62-330.301 and 62-330.302, F.A.C. and Part II of this Volume. If a design professional wishes to use a BMP that is found in another WMD's Applicant's Handbook Volume II, the criteria found in their Applicant's Handbook Volume II may be used if converted to meet criteria for this District found in Parts II, III and IV of this Volume.

5.1 Retention Pond Design Criteria and Guidelines

5.1.1 Description

The term "retention system" is defined as a storage area designed to store a defined quantity of runoff, allowing it to percolate through permeable soils into the shallow ground water aquifer. Stormwater retention works best using a variety of retention systems throughout the project site.

Soil permeability and water table conditions must be such that the retention system can percolate the desired runoff volume within a specified time following a storm event. After drawdown has been completed, the basin does not hold any water, thus the system is normally "dry." Unlike detention basins, the treatment volume for retention systems is not discharged to surface waters. Retention systems provide excellent removal of stormwater pollutants. Substantial amounts of suspended solids, oxygen demanding materials, heavy metals, bacteria, some varieties of pesticides and nutrients such as phosphorus are removed as runoff percolates through the vegetation and soil profile. Besides pollution control, retention systems can be utilized to promote the recharge of ground water to prevent saltwater intrusion in coastal areas or to maintain groundwater levels in aquifer recharge areas. Retention systems can also be used to help meet the runoff volume criteria for systems that discharge to closed basins or land-locked lakes.

5.1.2 Criteria

Retention ponds shall comply with all applicable requirements of Part II, III, and IV of this volume. The bottom of retention ponds are not required to be flat. The lowest elevation of the bottom of retention ponds shall be no less than 1 foot above the SHGWT. The retention pond shall have a freeboard of 1 foot above the maximum stage in order to function properly during storms greater than the design storm. Retention ponds shall be equipped with an emergency discharge system designed to pass runoff resulting from storm events larger than the design storm. Overflow structures shall be designed such that the top of the structure is below the top of the pond and above the maximum stage. Retention ponds with berms greater than 5 feet from the top of the berm to the lowest natural ground elevation shall comply with Section 5.8 of this Volume. The retention basin shall be stabilized with pervious material or permanent vegetative cover. The system cannot cause adverse secondary impacts to adjacent wetlands or other surface waters. The flow path of water from the inlets to the outlet should be maximized to ensure treatment. If short flow paths are unavoidable, the effective flow path can be increased by adding diversion barriers such as islands, peninsulas, or baffles to the pond. Inlet structures shall be designed to dissipate the energy of water entering the pond.

5.2 Dry Detention Ponds Design Criteria and Guidelines

5.2.1 Description

Since water discharged from the system must be treated, detention ponds cannot be designed to simply have a bleed down pipe at the pond bottom. The system must provide water quality treatment through underdrains, sidedrains, Vertical Volume Recovery Systems or other type systems. For the purposes of this section, water quality treatment system (WQTS) shall refer to underdrains, sidedrains, Vertical Volume Recovery Systems and other such systems.

Detention ponds are an option for the applicant where high water table conditions dictate that recovery of the stormwater treatment volume cannot be achieved by natural percolation and suitable outfall conditions exist to convey flows from the detention pond to receiving waters. These systems are intended to provide for the drawdown of the treatment volume. WQTS are utilized to treat the stormwater through sand or other adequate media in order to meet state water quality standards. The sand or other adequate media shall provide removal of stormwater pollutants, suspended solids, oxygen demanding materials, heavy metals, bacteria, some varieties of pesticides and nutrients such as phosphorus through the vegetation and media.

5.2.2 Criteria

Dry Detention ponds shall comply with all applicable requirements of Part II, III, and IV of this volume. The bottom of detention ponds are not required to be flat. The detention pond shall have a freeboard of 1 foot above the maximum stage for storms greater than the design storm. Dry detention ponds shall be equipped with an emergency discharge system designed to pass runoff resulting from storm events larger than the design storm. Overflow structures shall be designed such that the top of the structure is below the top of the pond. Overflow structures shall be designed such that the top of the structure is above the maximum stage. Dry Detention ponds with berms greater than 5 feet from the top of the berm to the lowest natural ground elevation shall comply with Section 5.8 of this Volume. Storage volumes in detention ponds shall be calculated so as not to include any volumes below the SHGWT. The system cannot cause adverse secondary impacts to adjacent wetlands or other surface waters. 48 hours prior to the construction of the WQTS, the district shall be notified and District staff shall be present during the installation. The flow path of water from the inlets to the outlet should be maximized ensure treatment. If short flow paths are unavoidable, the effective flow path can be increased by adding diversion barriers such as islands, peninsulas, or baffles to the pond. Inlet structures shall be designed to dissipate the energy of water entering the pond.

WQTS in a detention pond shall consist of a perforated drainage pipe which collects and conveys water following percolation from the basin through suitable soil media. The pipe system configuration (e.g., pipe size, depth, pipe spacing, and pipe inflow capacity) of the system must be designed to achieve the recovery time requirement. The WQTS shall utilize filter fabric or other means to prevent the soil from moving into the gravel envelope, if proposed. The WQTS shall provide capped and sealed inspection and cleanout ports which extend to the surface of the ground. The inspection and cleanout ports shall be located at the inlet and terminus of the system, and at a minimum, every 400 feet and every bend of 45 or more degrees. The perforated pipe shall be designed with a 12 inch minimum inside pipe diameter and a 3 foot minimum trench width. The perforated pipe shall be located within the trench section to minimize the accumulation of sediment in the aggregate void storage and maximize the preservation of this storage for stormwater treatment. It is recommended that the perforated pipe be located at or within 6 inches of the trench bottom.

5.3 Exfiltration Trench Systems Design Criteria and Guidelines

5.3.1 Description

An exfiltration trench is a subsurface system consisting of a conduit such as perforated pipe surrounded by natural or artificial aggregate which temporarily stores and infiltrates stormwater runoff. Stormwater passes through the perforated pipe and infiltrates through the trench walls and bottom into the ground.

These types of system are commonly referred to as underground vaults or underground storage units. Operation and maintenance is of great concern as sediment accumulation and clogging by fines can reduce the life of the system.

5.3.2 Criteria

Exfiltration trench systems shall comply with all applicable requirements of Part II, III, and IV of this volume. The bottom of pond is not required to be flat; however, the exfiltration trench does have to be flat. The pond shall have a freeboard of 1 foot above the maximum stage in order to function properly during storms greater than the design storm. The ponds shall be equipped with an emergency discharge system designed to pass runoff resulting from storm events larger than the design storm. Overflow structures shall be designed such that the top of the structure is below the top of the pond and above the maximum stage. Ponds with berms greater than 5 feet from the top of the berm to the lowest natural ground elevation shall comply with Section 5.8 of this Volume. The system cannot cause adverse secondary impacts to adjacent wetlands or other surface waters. The inspection and cleanout ports shall be located at the inlet and terminus of the system, and at a minimum, every 400 feet and every bend of 45 or more degrees. Standard precast concrete inlets and manholes may be used for inspection and cleanout access. Inlet structures shall include sediment sumps. 48 hours prior to the construction of the WQTS, the district shall be notified and district staff shall be present during the installation.

Exfiltration trench systems shall be designed so that aggregate in the trench is enclosed in filter fabric. Filter fabric may also be utilized directly surrounding the perforated pipe. The exfiltration trench system shall be designed so that the invert elevation of the trench is at or above the seasonal high ground water table elevation.

5.4 Wet Detention Design Criteria and Guidelines

5.4.1 Description

Wet detention systems are permanently wet ponds which are designed to slowly release collected stormwater runoff through an outlet structure. Wet detention systems are the recommended BMP for sites with moderate to high water table conditions. Wet detention treatment systems provide significant removal of both dissolved and suspended pollutants by taking advantage of physical, chemical, and biological processes within the pond. Wet detention systems offer an effective alternative for the long term control of water levels in the pond, provide a predictable recovery of storage volumes within the pond, and are easily maintained by the maintenance entity. In addition to providing good removal of pollutants from runoff, wet detention systems also provide other benefits such as flood detention, passive recreational activities adjacent to ponds, storage of runoff for irrigation, and pleasing aesthetics. As stormwater treatment systems, these ponds should not be designed to promote in-water recreation (i.e., swimming, fishing, and boating).

5.4.2 Criteria

Wet detention ponds shall comply with all applicable requirements of Part II, III, and IV of this volume. The control elevation shall be set at or above the SHGWT and at or above the design tailwater elevation. The bottom of wet detention ponds are not required to be flat. The detention pond shall have a freeboard of 1 foot above the maximum stage in order to function properly during storms greater than the design storm. Wet detention ponds shall be equipped with an emergency discharge system designed to pass runoff resulting from storm events larger than the design storm. Overflow structures shall be designed such that the top of the structure is below the top of the pond and above the maximum stage. Wet detention ponds with berms greater than 5 feet from the top of the berm to the lowest natural ground elevation shall comply with Section 5.8 of this Volume. Storage volumes in detention ponds shall be calculated so as not to include any volumes below the SHGWT. The system cannot cause adverse

secondary impacts to adjacent wetlands or other surface waters. The pond must be designed so that the pond side slopes are no steeper than 4H: 1V (horizontal: vertical). Drawdown devices with a width smaller than 3 inches shall include a device to eliminate clogging. The flow path of water from the inlets to the outlet should be maximized to ensure treatment. If short flow paths are unavoidable, the effective flow path can be increased by adding diversion barriers such as islands, peninsulas, or baffles to the pond. Inlet structures shall be designed to dissipate the energy of water entering the pond. A dewatering plan, if required, shall be the minimum plan required to provide reasonable assurance that water discharged for the site will meet state water quality standards. If the contractor discovers the plan is ineffective, he shall design and implement a plan that is effective.

5.4.3 Permanent Pool

The permanent pool shall be sized to provide at least a 14-day residence time based upon average wet season rainfall (rainfall occurring over the wettest four months of an average year). Additional permanent pool volume is required for wet detention systems which directly discharge to OFWs. The maximum depth of the permanent pool shall be 12 feet. The minimum depth of the permanent pool shall be 2 feet. An aerobic environment should be maintained throughout the water column in wet detention ponds.

5.5 Swales Systems Design Criteria and Guidelines for Swale Systems

5.5.1 Description

Swales are a man-made or natural system shaped or graded to required dimensions and designed for the conveyance and rapid infiltration of stormwater runoff. Swales are designed to infiltrate a defined quantity of runoff through the permeable soils of the swale floor and side slopes into the shallow ground water aquifer. Turf is established to promote infiltration and stabilize the side slopes. The swale holds water only during and immediately after a storm event, thus the system is normally “dry.” Swales provide excellent removal of stormwater pollutants. Substantial amounts of suspended solids, oxygen demanding materials, heavy metals, bacteria, some varieties of pesticides and nutrients such as phosphorus are removed as runoff percolates through the vegetation and soil profile. Besides pollution control, swale systems can be utilized to promote the recharge of groundwater to prevent saltwater intrusion in coastal areas, and to maintain ground water levels in aquifer recharge areas. Swales can be incorporated into the design of a stormwater management system to help meet the runoff volume criteria. Swales can also be utilized to provide pre-treatment of runoff prior to its release to another treatment BMPs.

5.5.2 Criteria

Swale systems shall comply with all applicable requirements of Part II, III, and IV of this volume. Swales, must be designed to treat, through percolation or evapotranspiration, the required water quality volumes as found in Part IV of this volume or a volume of stormwater equal to at least 80 percent of the runoff resulting from a design storm with a three-year, one-hour rainfall depth and SCS type II distribution falling on average antecedent moisture conditions. Swale shall have side slopes no steeper than or equal to 3:1 (horizontal to vertical). Construction of swale systems must be in conformance with procedures that avoid degradation of swale infiltration capacity due to compaction and construction sedimentation. Swales shall be stabilized with vegetative cover suitable for soil stabilization, stormwater treatment, and nutrient uptake. The swale shall be designed to take into account the soil erodibility, soil percolation, slope, slope length, and drainage area so as to prevent erosion and reduce pollutant concentrations.

5.6 Vegetated Natural Buffers Design Criteria and Guidelines

5.6.1 Description

Vegetated natural buffers (VNB) are defined as naturally vegetated areas that are set aside between developed areas and a receiving water or wetland for stormwater treatment purposes. Under certain conditions, VNBs are an effective best management practice for the control of nonpoint source pollutants in overland flow by providing opportunities for filtration, deposition, infiltration, absorption, adsorption, decomposition, and volatilization. VNBs are most commonly used as an alternative to swales or berms installed between back-lots and the receiving water. Buffers are intended for use to avoid the difficulties associated with the construction and maintenance of backyard swales controlled by individual homeowners. Potential impacts to adjacent wetlands and upland natural areas are reduced because fill is not required to establish grades that direct stormwater flow from the back of the lot towards the front for collection in the primary stormwater management system. In addition, impacts are potentially reduced since buffer strips can serve as wildlife corridors, reduce noise, and reduce the potential for siltation into receiving waters. Vegetative natural buffers are not intended to be the primary stormwater management system for residential developments. They are most commonly used only to treat those rear-lot portions of the development that cannot be feasibly routed to the system serving the roads and fronts of lots.

5.6.2 Criteria

Vegetated natural buffers shall comply with all applicable requirements of Part II, III, and IV of this volume. The use of a VNB for other types of development shall only be allowed if the applicant demonstrates that there are no practical alternatives for those portions of the project. The existing vegetation must not be disturbed during the development of the project. In all cases, a minimum buffer width of 25 feet is required to ensure the integrity of the treatment system. To promote overland flow, the maximum width (dimension parallel to the flow direction) of the contributing area is 300 feet. The contributing area must be stabilized with permanent vegetative cover. No fertilizer shall be applied to the contributing area. Erosion control measures must be utilized during development of the contributing area so as to prevent siltation of the buffer area.

For systems that discharge to receiving water bodies other than OFWs, the VNB must be designed to provide at least 200 seconds of travel time by overland flow through the buffer for the 2-year, 24-hour storm event. Systems which directly discharge to OFWs must be designed to provide at least 300 seconds of travel time by overland flow through the buffer for the 2-year, 24-hour storm event. The maximum slope of VNB must not be greater than 15%. The length of the buffer (measured perpendicular to the runoff flow direction) must be at least as long as the length of the contributing runoff area. Runoff from the adjacent contributing area must be evenly distributed across the buffer strip to promote overland flow.

A legal reservation, in the form of an easement or other limitation of use, must be recorded which provides preservation of the existing undeveloped area in its natural state. The reservation must also include access for maintenance of the VNB unless the operation and maintenance entity wholly owns or retains ownership of the property. The legal reservation must include at least the entire area of the VNB.

5.7 Borrow Pits & Ponds Design Criteria and Guidelines

5.7.1 Description

Borrow pits are defined in Part II of Volume I. Borrow pits typically do not hold water for extended periods of time. Ponds may be defined as a body of standing water either natural or man-made, which is usually smaller than a lake. Some ponds are created specifically for habitat restoration or water treatment. Others are designed for aesthetic ornamentation as landscape or architectural features. Ponds hold water for four months of the year or more.

5.7.2 Criteria

Borrow Pits and ponds shall comply with all applicable requirements of Part II, III, and IV of this volume.

The materials to be excavated from borrow pits must be homogenous and that grading or sorting will not occur. Materials removed from borrow pits or ponds may be used on site or may be removed from the site. Borrow pits may be filled in after completion of construction with clean material which do not include oils, greases, construction debris, household trash, or hazardous materials or waste. Ponds may have natural liners such as compacted clay or limerock or manmade material such as impermeable plaster liners. The bottom of borrow pits and ponds shall be above the static water elevation. Borrow pits and ponds with berms greater than 5 feet from the top of the berm to the lowest natural ground elevation shall comply with Section 5.8 of this volume.

The overflow structure of the pond shall be below the top of the pond. An overflow system shall be designed such that it can pass a storm greater than the design storm without damage. The registered professional shall calculate the normal water and 100 year flood elevation of the pond.

Borrow pits shall have at least one boring per two acres spatially arranged throughout the area of the proposed borrow pit. The underlying geology of the site and a subsurface cross section of the project site shall be determined and mapped. Documents shall provide reasonable assurance that the underlying aquifer will not be disturbed. Restoration plans should include detailed descriptions of all vegetative restoration efforts, stem densities of trees to be planted, species of grass to be sown, monitoring efforts and bank stabilization techniques. A survey shall be provided that determines the number and location of active gopher tortoise burrows or historical artifacts. The applicant shall provide an erosion and sediment control plan that provides reasonable assurance that the borrow pit will not erode and encroach on adjacent landowners. Waters diverted around the pit shall be discharged in the same general direction and pre-construction rate. A dewatering plan, if required, shall be the minimum plan required to provide reasonable assurance that water discharged for the site will meet state water quality standards. If the contractor discovers the plan is ineffective, he shall design and implement a plan that is effective.

5.8 Dams and Impoundments Design Criteria and Guidelines

5.8.1 Description

Dams and Impoundments are both defined in Part II of Volume I. Dams and impoundments are classified as follows

- **Low Hazard Potential**
Dams assigned the low hazard potential classification are those where failure or mis-operation results in no probable loss of human life and low economic and/or environmental losses. Losses are principally limited to the owner's property.
- **Significant Hazard Potential**
Dams assigned the significant hazard potential classification are those dams where failure or mis-operation results in no probable loss of human life but can cause economic loss, environmental damage, disruption of lifeline facilities, or can impact other concerns. Significant hazard potential classification dams are often located in predominantly rural or agricultural areas but could be located in areas with population and significant infrastructure.
- **High Hazard Potential**
Dams assigned the high hazard potential classification are those where failure or mis-operation will probably cause loss of human life.

5.8.2 Criteria

Dams and impoundments shall comply with all applicable requirements of Part II, III, and IV of this volume. The discharge capacity and/or storage capacity must be capable of safely handling the following

spillway design floods. Low hazard dams, less than 25 feet in height, shall safely handle the 100-year critical duration rainfall event. All other dams shall safely handle the Probable Maximum Precipitation (PMP). The PMP for the District area is 31 inches for a period over a 200-square mile drainage area. This precipitation must be increased by a multiplier of 1.23 for 10-square mile drainage basins and 1.05 for 100-square mile drainage basins. The PMP in design serves to eliminate the possibility of the addition of sudden structural failure to already serious flood conditions. The design height of an earth embankment must be sufficient to contain or control the most restrictive of the following situations, acting singularly or in combination:

- (a) Peak water elevation in the reservoir or pond area;
- (b) Wave run-up above the peak water elevation;
- (c) Hydraulic head to achieve minimum, emergency spillway discharge;
- (d) Anticipated soil consolidation and settlement in the embankment soil mass and foundation zone; plus
- (e) An additional amount as a factor of safety based upon the accuracy and precision of the data and calculations used to determine any of these conditions.

The elevation difference between the maximum height of the earth embankment and the normal water level in the reservoir or pond is called freeboard. Freeboard shall be called out on the construction plans.

5.8.3 Embankment Slope Stability

The applicant's engineer shall analyze the stability of embankment slopes using generally accepted methods based on sound engineering principles and document all analyses or considerations in appropriate design reports and files. The design professional must design and provide documentation that the embankment has adequate factors of safety and will not fail due to the below general failure modes:

- **Overtopping**, where the quantity of floodwater entering the system is greater than its capacity and water pours over the top of the embankment. Embankment failure results from erosion on the backside of the levee caused by water cascading over the crown and gradually washing soil away until the full cross section is breached. Embankments constructed of clay soil can withstand significantly more overtopping than levees constructed of silt or sandy soil.
- **Seepage and Piping**, where floodwater seeps through or under an embankment and carries the embankment or foundation material with it. Some seepage through an earthen embankment is relatively common, but when the seepage finds or creates a drainage path, or "pipe," through erodible material, such as a sand strata, material is gradually washed out through a "boil" on the landside of the embankment. If unchecked, sufficient material can exit the embankment through the boil to create a large void inside the embankment, resulting in a depression or "slump" in the crown of the levee. If the crown slumps below the water surface elevation, overtopping will occur through the depression and lead to failure.
- **Erosion**, where high water velocity or wave action removes material from the embankment or the stream bank adjacent to the embankment, leading to slope instability and increased seepage.
- **Sliding (Rotational Slip)**, where seepage through the embankment, or even through saturation caused by extensive duration of high water, weakens the embankment and/or foundation material to the point where the weight of soil exceeds its internal strength. The embankment slope then slides. This type of sliding is a characteristic problem for embankments built of clay soil.
- **Sloughing**, where seepage through the embankment causes the outermost soil on the levee slope to slide down. Progressive sloughing shortens the seepage path through the embankment, causing increasingly heavy seepage until the embankment gives way. Sloughing is a characteristic problem of silty and sandy levees.

5.8.4 Construction Standards

Design

1. Site Investigation – The general area for use as a settling area shall be carefully inspected by the design engineer prior to selection of the exact location for a dam. Areas of uneven natural subsidence, sink-hole, pockets of organic matter, or other unstable soils shall be avoided, unless special provisions are made for their correction.
2. Soil Testing – A program of soil sampling and testing adequate to determine the characteristics of the foundation material which will support the proposed dam shall be performed. Sampling shall include borings and/or in-place samples from the exposed excavation face. All borings shall be logged using a recognized engineering soil classification system (such as Unified System) with location and depths of samples recorded on the log. Tests including but not limited to, the determination of in-placed densities, shear-strength, and permeabilities of the foundation and embankment soils shall be performed on either undisturbed samples or on the in-place soil. Tests on embankment soils shall be performed on samples remolded to the densities to be used in construction. All soil test data used for design shall be derived from tests performed in compliance with the American Society of Testing Materials, American Association of State Highway Officials, or U. S. Army Corps of Engineers soil testing specifications and procedures.
3. Cross-Section Design – The design height of an earth embankment should be sufficient to prevent overtopping during passage of the design storm event plus the freeboard required for wave action. The design height must also meet the requirements for minimum emergency spillway depth. The design shall provide positive seepage control features, such as, but not limited to:
 - a. Cut-off trench in natural soil foundations;
 - b. Clay core;
 - c. Blanket drain; and
 - d. Chimney drain and toe drain.
4. Stability Analysis – The embankment and foundation are to be analyzed for stability against failures found in Section 5.8.3. The appraisal of stability is to be based on the comparative performance of similar embankments and a slope stability analysis using engineering judgment. Settlement, seepage, and cracking are to be considered and adequate measures included to control or safely compensate for their effects. Analyses are to be made for the conditions or periods during the design life which are the most critical or severe. These conditions will be for various moisture and loading conditions of the embankment and foundation. These are to include the following conditions:
 - a. Immediately after construction;
 - b. During full reservoir steady seepage; and
 - c. During partial or complete sudden drawdown.

In each case, the analysis shall be made using engineering property values determined by laboratory tests simulating the assume condition. Soil mechanics data used may be from specific testing for the site or by documented reference to data which can be correlated. The method of slope stability analysis used shall be appropriate for the loading condition and location and shape of potential failure surface. The embankment and foundation conditions shall be determined to a degree consistent with the complexity of the site and the potential for failure. The adequacy of the geologic and soil investigation, along with the significance of minor variations, shall be evaluated in the stability, seepage, and settlement analyses. Seepage control shall be added to all penetrations of the earth embankment as may be required to ensure containment and control of the impounded waters or stability of the soil mass.

5. Design Safety Factors – The design engineer shall use generally accepted minimum safety factors.

Site Preparation – Ground which will become the foundation of earth dams shall be stripped of all vegetation and organic detritus or residue, including muck, mud, slimes, or other material which would flow or undergo excessive consolidation under heavy loading. All earth foundation surfaces on which fill is to be placed shall be scarified or moistened and compacted prior to spreading of first course fill material, and the dam base shall be well drained during construction, except when placing hydraulic fill.

Material to be Used – Material used for earthen dams shall be free of stumps, vegetation, trees, palmettos, muck, and other extraneous matter which could affect the compactability, density, permeability, or shear strength of the finished dam. Tailings may be used for dam fill. Please contact District staff to discuss this during a pre-application meeting.

Water Level Control – Sufficient water level control structures shall be installed in the impoundment area behind an earthen dam to maintain the minimum required freeboard and to accommodate the release of storm water resulting from heavy rainfall.

Methods of Construction

- a. Each new dam shall be constructed to meet or exceed the minimum safety requirements of the specifications and design for that dam. Draglines, drag scrapers, tractor, or other appropriate earth moving equipment shall be used to place materials used in dam construction. Materials used in rolled dams shall be blended prior to compaction. The soil shall be compacted and density tests shall be performed to ensure that the designed densities are obtained. A qualified representative of the design engineer shall be present on the site each working day during construction of a rolled dam to ensure that materials and construction methods meet all specifications of the design. The District engineer shall be advised of the date on which construction or shaping of a new dam will begin so that he can inspect the site.
- b. Areas around any water level control structure pipe, any other conduit, or any surface of discontinuity between materials within the mass of the dam shall be carefully installed to avoid potential concentration of seepages. All conduits through dams shall have two or more seepage collars spaced in accordance with good engineering practices pertinent to the material used for the fill. Two collars will be installed within the core when there is core within a dam. All pipes and joints in pipes extending through a dam shall be made leak-proof and shall be constructed of material suitable for the fluids carried and load imposed. In order to avoid leaks associated with differential settlement, conduits through dams shall not be rigidly supported by piles or piers. Backfill around conduits shall be of a density that is equal to or greater than those of the surrounding embankment. Particular attention shall be devoted to the lower third of the conduit.

Documentation

1. The owner of an earthen dam should maintain in a permanent file the following construction records pertaining to said dam:
 - Aerial photo of construction site.
 - Design drawings and calculations.
 - Design specifications.
 - Results of all soil tests on foundations and fill materials.
 - Logs of borings and engineering geology reports.
 - Certified copies of construction progress inspections pertinent to core trench, toe drain, internal drains, and other significant phases of the structure. Photographs of various structural items may be included in the file.
 - Description of and justification for all deviations or variances from the design plans or specifications.

Inspections

Personnel or agents of the District may accompany inspectors on any routine inspection required by the District, or inspect settling areas at any other time which is reasonable under the circumstances involved. They may also examine any routine inspection reports and be furnished copies thereof upon request.

5.8.5 Principal Spillways

The structural design and detailing of principal spillways are to conform to the recommendations of National Engineering Handbook, Section 6, “Structural Design” and NRCS standard drawings. All component parts such as gates and trash racks are to be equally durable.

Capacity of Principal Spillway

The required capacity of the principal spillway depends on:

- The purpose of the dam;
- The amount of storage provided by the retarding pool;
- The kind of emergency spillway;
- Stream channel capacity and stability downstream;
- Potential damage from prolonged storage in the retarding pool;
- Potential damage downstream from prolonged high outflow rates;
- The possibility of substantial runoff from two or more storms in the time required to empty the retarding pool;
- Limitations imposed by water rights or other legal requirements;
- Environmental concerns;
- Planned or potential alterations of the channel downstream; and
- The necessity to pass base and flood flows during construction.

A controlled spillway must be provided which will essentially drain the impoundment unless express approval is secured from the District.

5.8.6 Emergency Spillways

Emergency spillways are provided to convey excess water through, over, or around a dam. They are usually open channels excavated in natural earth, earth fill, rock, or constructed of reinforced concrete. Emergency spillways are to be proportioned so they will pass the emergency spillway hydrograph at the safe velocity determined for the site. They are to have sufficient capacity to pass the freeboard hydrograph with the water surface in the reservoir at or below the elevation of the design top of the dam.

5.8.7 Reservoir Regulation

A reservoir regulation plan should be developed so that regulating the reservoir and discharges under normal and emergency conditions are designed to assure that they do not constitute a danger to the safety of the dam or the human life or property downstream. In the case of High (Class C) hazard dams, the reservoir regulation plan must also include an analysis of the probable consequences of a sudden or catastrophic failure of the dam and associated structures containment of the maximum contained water volume in the reservoir or pond. The analysis, sometimes called a “dam breach” analysis, shall include the development of a downstream evacuation map.

5.9 Sensitive Karst Areas Design Criteria and Guidelines

5.9.1 Background of the Sensitive Karst Area Design Criteria

Paragraph 62-346.301(1)(i), F.A.C., provides that a condition for issuance of a permit includes compliance with any applicable special basin or geographic area criteria rules. The only area within the geographical extent of the Suwannee River Water Management District for which additional geographic criteria have been developed is a Sensitive Karst Area (SKA).

The Floridian Aquifer System is the drinking water source for most of the population in the geographical extent of the District. In parts of the district, limestone (or dolostone) that makes up or comprise this aquifer system occurs at or near the land surface. Sediments overlying the limestone can be highly

permeable. The limestone, due to its chemical composition, is susceptible to dissolution when it interacts with slightly acidic water. “Karst” is a geologic term used to describe areas where landscapes have been affected by the dissolution of limestone or dolostone, including areas where the formation of sinkholes is relatively common. Sensitive Karst Areas reflect areas with hydrogeological and geologic characteristics relatively more conducive to potential contamination of the Floridian Aquifer System from surface pollutant sources. The formation of karst-related features, such as sinkholes is also more likely to occur in SKAs.

5.9.2 Hydrogeology of the Sensitive Karst Areas

Throughout the majority of the geographical extent of the district the highly porous limestone that comprises the Floridian Aquifer System is generally overlain by tens to hundreds of feet of sands, clays, and other material. Where present, this material may act to protect, to varying degrees, the Floridian Aquifer System from surface pollutants. Surface water seeps through this material slowly, which allows for some degree of filtration, adsorption, and biological transformation or degradation of contaminants. In SKAs, however, the limestone that comprises the Floridian Aquifer System may occur at or near the land surface and sand overburden, confining clays, or other confining cover material is absent or discontinuous. As a result, there can be rapid movement of surface water and possibly entrained contaminants into the aquifer. The SKAs are areas of relatively high recharge to the Floridian Aquifer System. Floridian Aquifer System ground water levels vary from land surface to approximately 290 feet below land surface in the SKAs.

One factor that makes the SKAs particularly prone to stormwater contamination is the formation of solution pipe sinkholes within retention basins. Solution pipe sinkholes are common in these areas and form due to the collapse of surficial material into vertical cavities that have been dissolved in the upper part of the limestone. They are also formed by the movement of surface material into the underlying porous limestone. In most cases, the solution pipes are capped by a natural plug of sands and clays. If the cap is washed out (as may happen if a large volume of water is stored over the solution pipes), the resulting solution pipe sinkhole can act as a direct pathway for the movement of surface water into the Floridian Aquifer System. Solution pipe sinkholes and other types of sinkholes may open in the bottom of stormwater retention basins. The capping plug or sediment fill may be reduced by excavation of the basin. Stormwater in the basin may increase the hydraulic head on the remaining material in the pipe throat. Both of these factors can wash material down the solution pipe. Solution pipes act as natural drainage wells and can drain stormwater basins. The irregular weathering of the limestone surface in the SKAs contributes to uncertainty and errors in predicting the depth from land surface to limestone.

5.9.3 Additional Design Criteria for Sensitive Karst Areas

In addition to the design criteria for projects outside of the SKAs, projects located within the SKAs also must meet the additional design criteria.

Stormwater management systems shall be designed and constructed to prevent direct discharge of untreated stormwater into the Floridian Aquifer System. Such stormwater management systems also shall be designed and constructed in a manner that avoids breaching an aquitard and such that construction excavation will not allow direct mixing of untreated water between surface waters and the Floridian Aquifer System. The system shall also be designed to prevent the formation of solution pipes or other types of karst features in the SKAs. Test borings located within the footprint of a proposed stormwater management pond must be plugged in a manner to prevent mixing of surface and ground waters.

A minimum of three feet of unconsolidated sediment or soil material between the surface of the limestone bedrock and the complete extent of the bottom and sides of the stormwater basin at final completion of the project. Excavation and backfill of unconsolidated sediment or soil material shall be conducted, if necessary to meet these criteria. As an alternative, an impermeable liner can be used to ensure that

stormwater is isolated from communication with groundwater (e.g., for wet detention). This provision is presumed to provide reasonable assurance of adequate treatment of stormwater before it enters the Floridian Aquifer System;

To reduce the potential for solution pipe sinkhole formation caused by newly created additional hydraulic head conditions, stormwater storage areas are limited to a maximum of 10 feet of vertical staging (shallower depths are encouraged), as measured for dry ponds from the bottom of the pond to the design high water level; and for wet ponds 10 feet of vertical staging as measured from the seasonal high ground water table to the design high water level, and shall have a horizontal bottom (no deep spots); and if during construction or operation of the stormwater management system, a structural failure is observed that has the potential to cause the direct discharge of surface water into the Floridian Aquifer System, corrective actions designed or approved by a registered professional shall be taken as soon as practical to correct the failure. A report prepared by a registered professional must be provided as soon as practical to the District for review and approval that provides reasonable assurance that the breach will be permanently corrected.

PART VI – OPERATION AND MAINTENANCE

6.1 General

Applications to construct, alter, and maintain a stormwater management system also constitutes an application to operate and maintain the system. A permit to operate a system is granted concurrently with the permit to construct, maintain or alter the system. The operation phase of all ERP permits lasts for the life of the system. After a permit has been issued, construction of the permit shall follow the conditions of the permit and the rules and requirements as found in Rule 62-330, F.A.C. and the Applicant's Handbook Volume I. Transfer of the permit to the operation and maintenance phase shall follow the conditions of the permit and the rules and requirements found in Rule 62-330, F.A.C., and the Applicant's Handbook Volume I. Operation and maintenance of the system shall follow the conditions in the permit and the rules and requirements as found in Rule 62-330, F.A.C., and the Applicant's Handbook Volume I.

6.2 Entity Requirements

In addition to the acceptable entities as found in Applicant's Handbook Volume I, this District will allow the following entity:

Unincorporated associations of owners who share a surfacewater management system or who have portions or individual components of a larger surfacewater management system on their property are generally not acceptable operation and maintenance entities. However, for surfacewater management systems composed entirely of swales which are permitted to serve a private road or drive providing access to no more than five parcels of land, each larger than one acre, the district will accept such unincorporated associations. The district shall place limiting conditions on such permits to insure owners or future owners of such lands understand that operation and maintenance of the surfacewater management system is the undivided responsibility of the owners.

6.3 Operation Phase and Release of Bond

Upon receipt of an as built certification package and transfer to operation and maintenance phase, the performance bond or surety will be released.

6.4 Inspections and Reporting

Inspections and reporting shall be in accordance with Section 373.423, F.S., (2012), Chapter 62-330, F.A.C., and Applicant's Handbook Volume I. The permittee and/or Operation and Maintenance entity, after receiving prior or reasonable notice, shall give permission and allow district personnel with proper identification, access to the project. District personnel shall inspect, sample, test and review the project as necessary to ensure compliance with the specifications of the application and permit.

6.5 Compliance

Complaints shall be submitted in compliance with the criteria in Chapter 40B-1.705, F.A.C. and shall proceed as per the criteria in 40B-1.510, F.A.C and the Governing Board policy on compliance and enforcement.

6.6 Enforcement

Parts I and IV of Chapter 373, FS, provide for the enforcement of District rules by administrative and civil complaint. The District also has the authority to obtain the assistance of county and city officials in

the enforcement of the rules in accordance with Sections 373.603 and 373.609, F.S., (2012). Any person, who violates any provisions of Chapter 373 or 403, FS, the rules adopted thereunder, or orders of the District, is subject to civil fines or criminal penalties as provided in Section 373.430, FS., (2012).

Enforcement shall be in accordance with Chapter 373, F.S. Enforcement shall proceed following the Governing Board policy on compliance and enforcement.

District Boundary

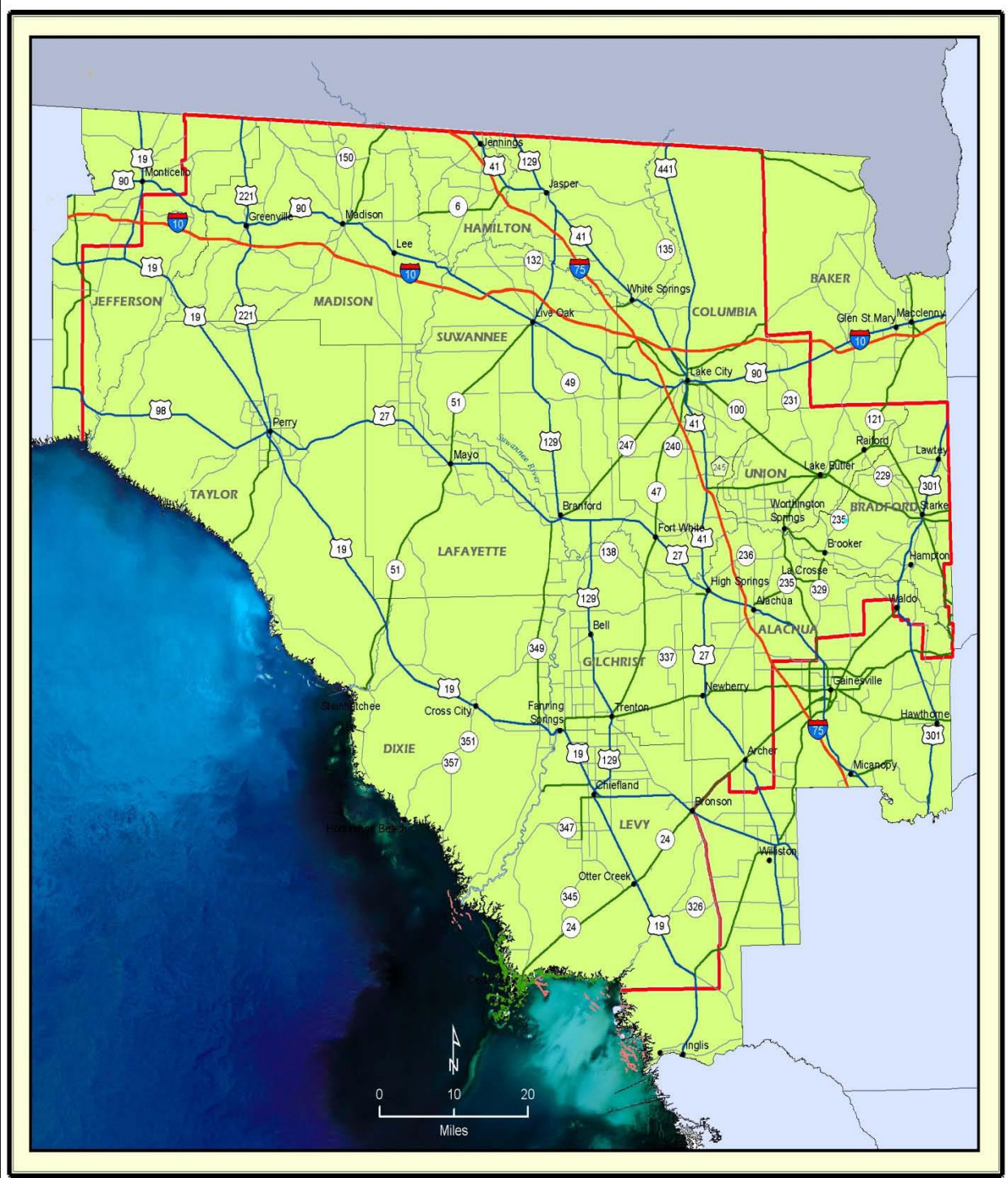

Alachua County Boundary

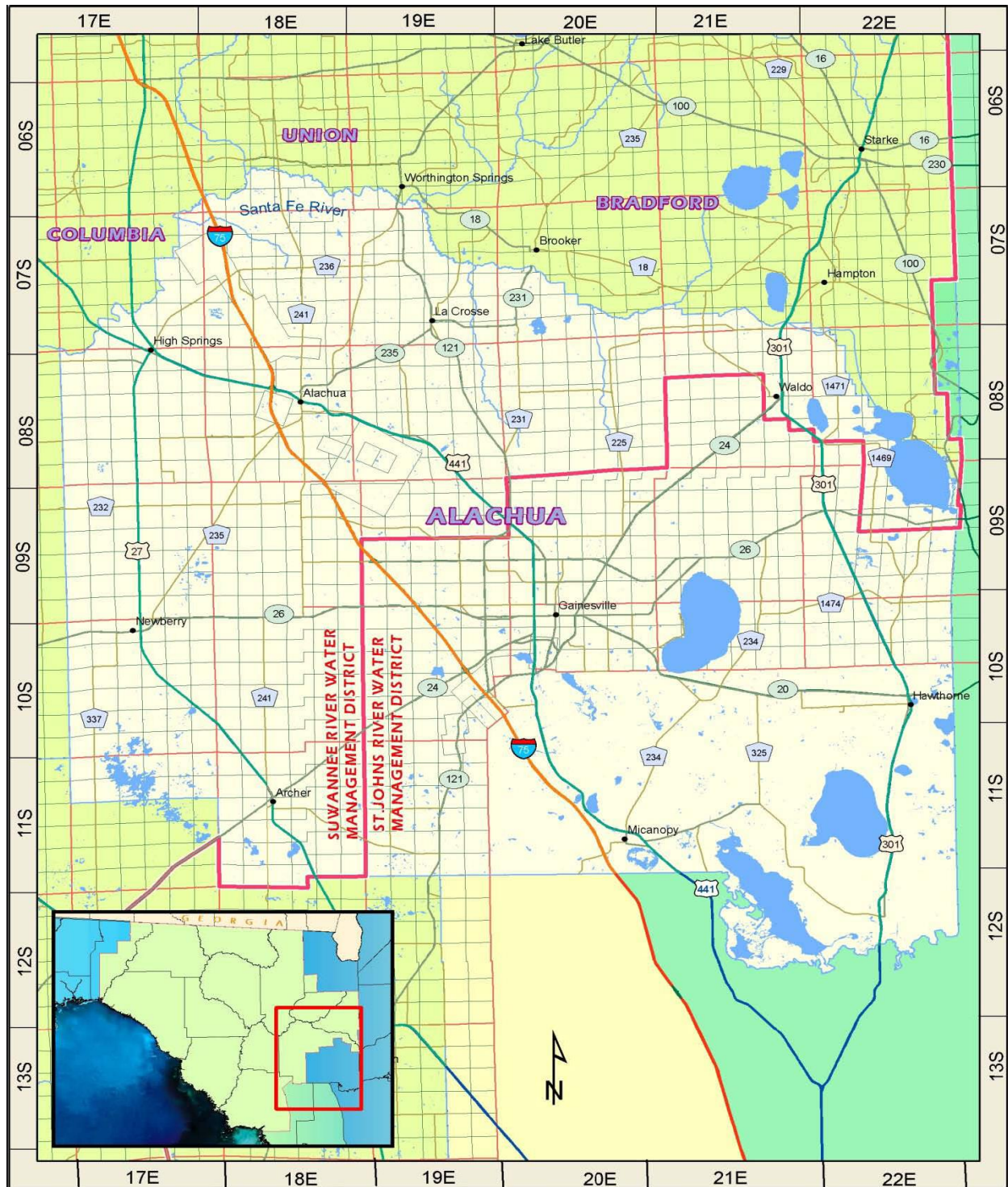

Baker County Boundary

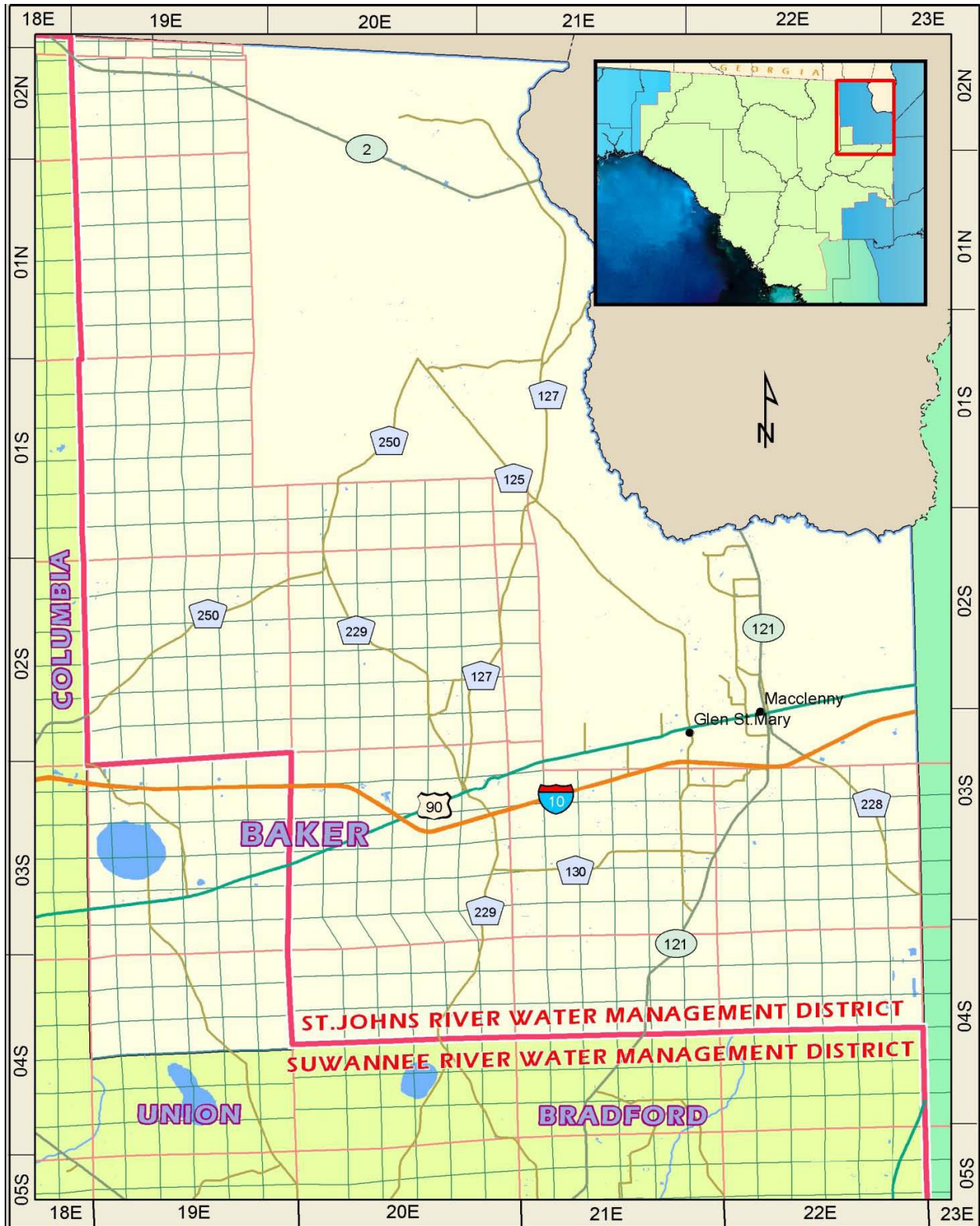

Bradford County Boundary

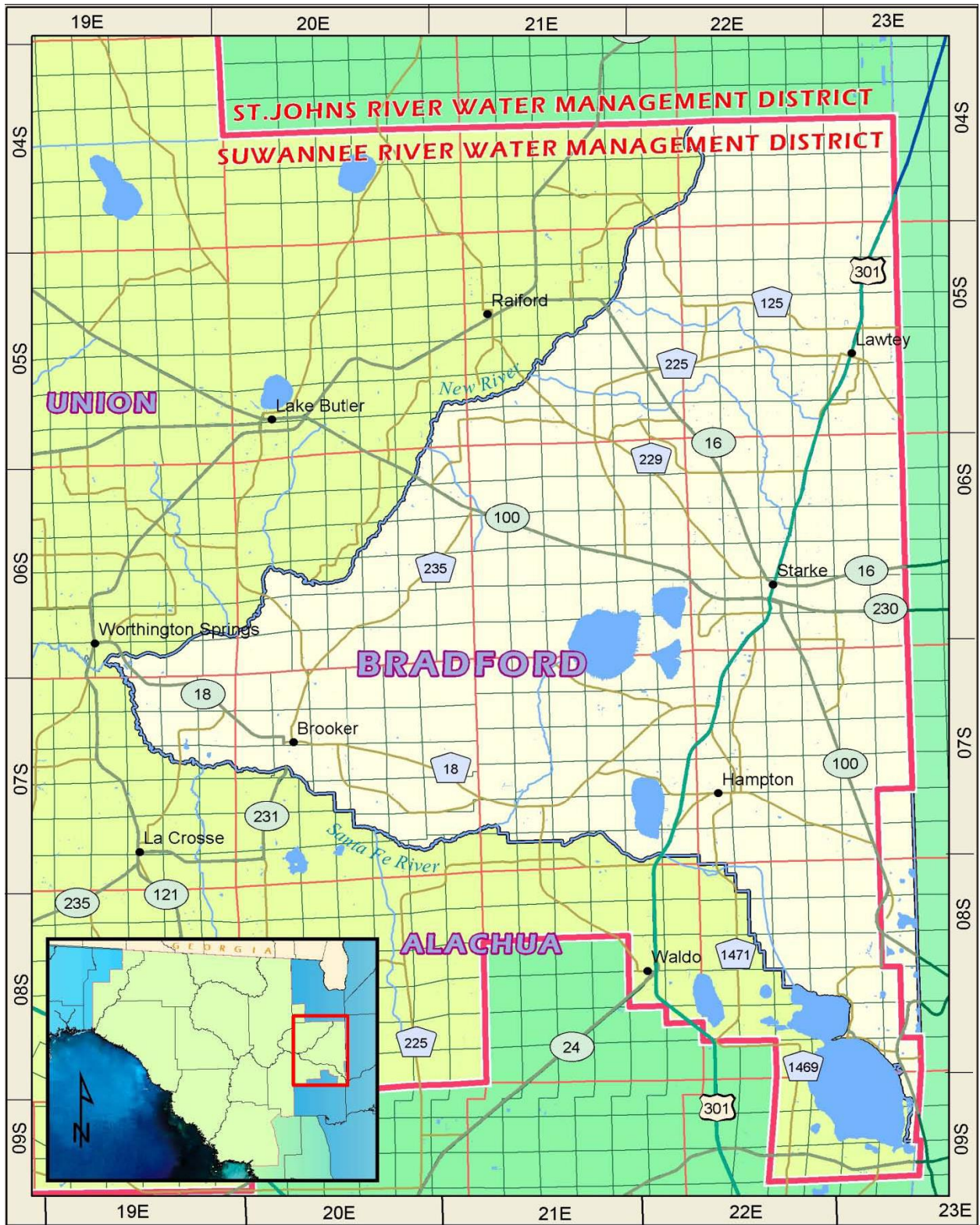

Jefferson County Boundary

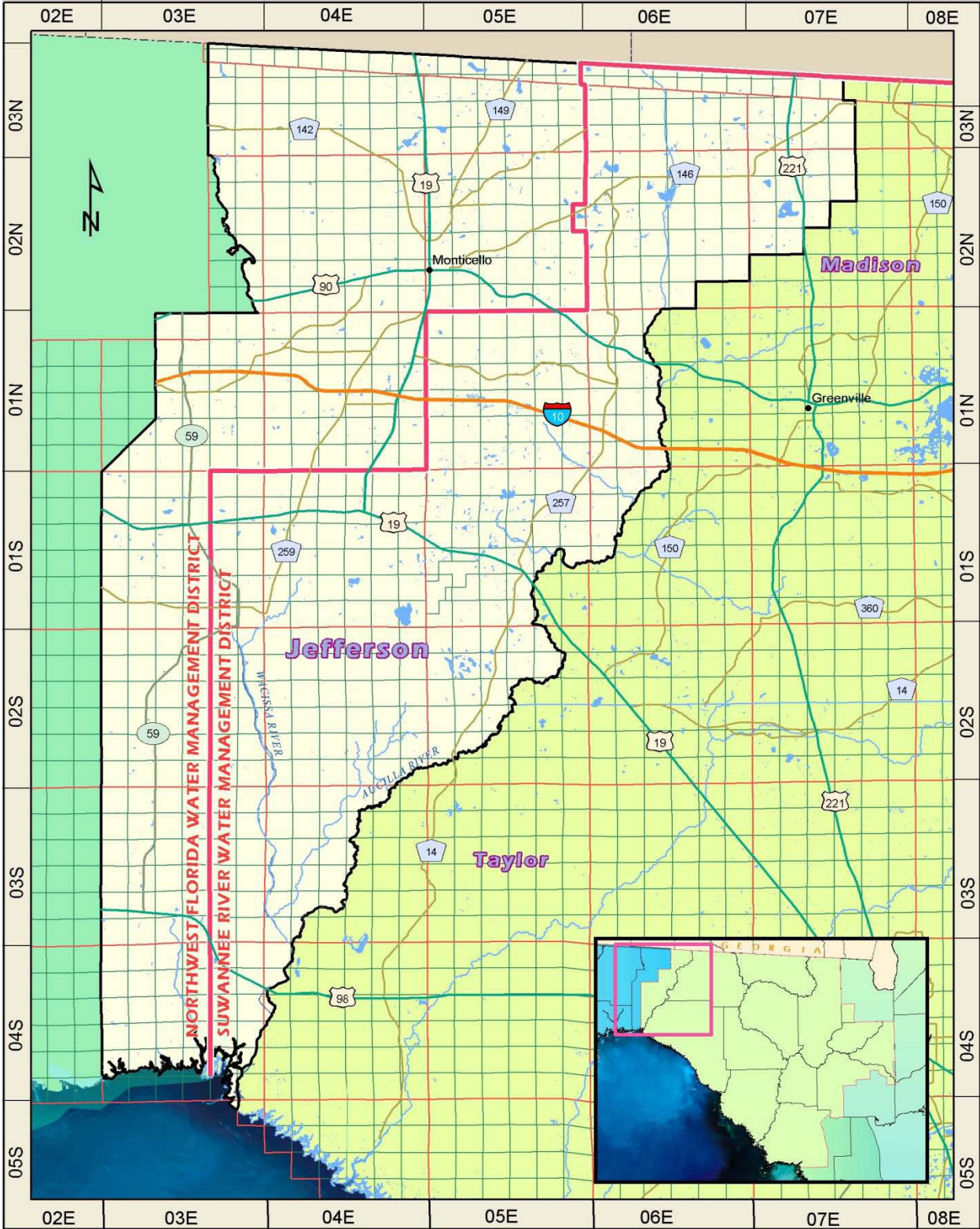

Levy County Boundary

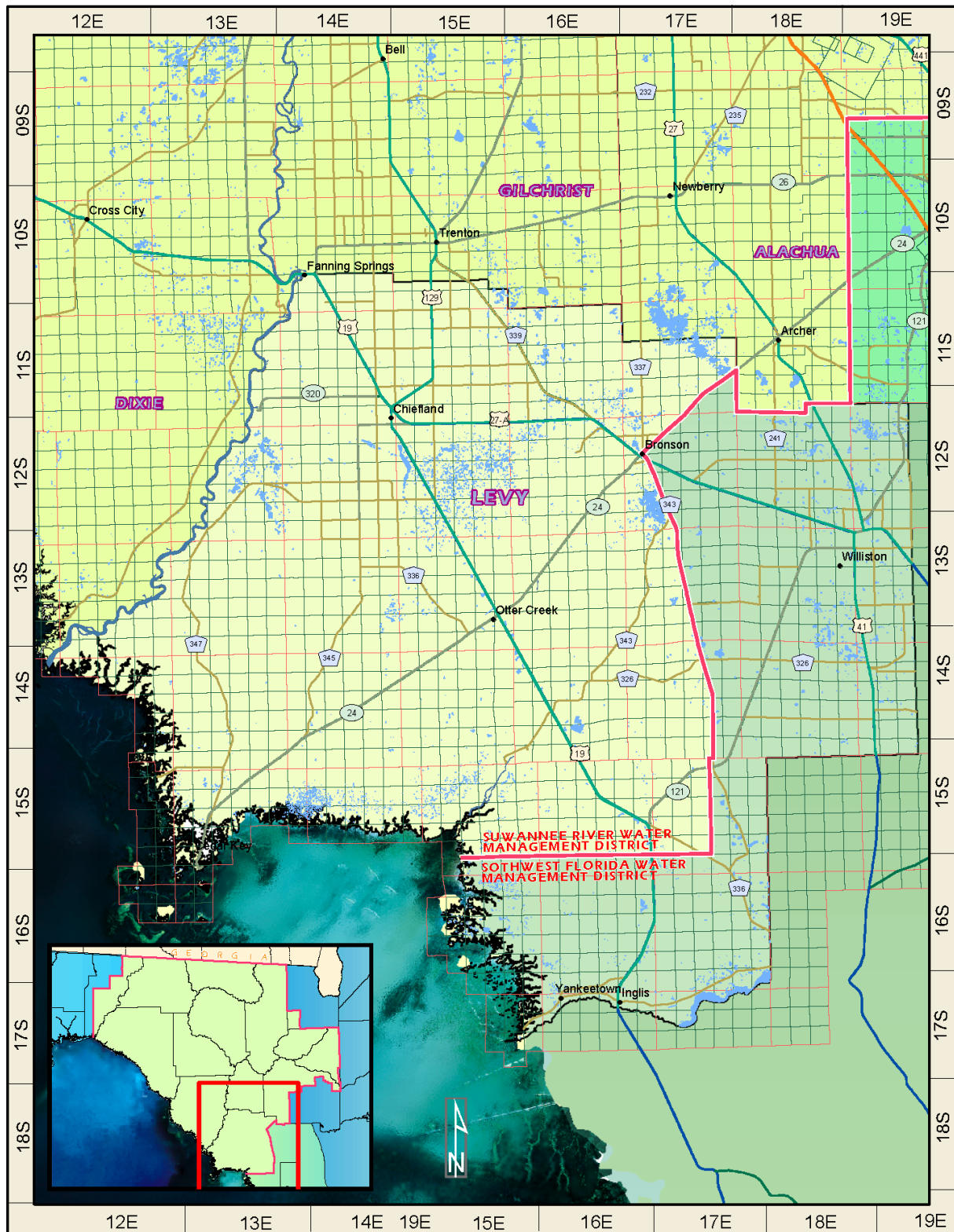

District Rainfall Distribution Data

Values for P_{total} (inches)¹

For the counties of Madison, Hamilton, Suwannee, Columbia, Baker and Union.

Frequency (years)	Duration (hours)							
	1	2	4	8	24	72	168	240
3	2.50	2.64	3.08	3.52	4.56	5.80	7.30	8.00
10	3.05	3.70	4.40	5.12	6.72	8.30	10.10	11.80
25	3.45	4.30	5.12	6.00	7.92	10.00	12.30	14.00
100	4.20	5.10	6.08	7.36	9.84	12.40	14.00	16.10

For the counties of Taylor, Lafayette, Dixie, Gilchrist, Levy, Alachua and Bradford.

Frequency (years)	Duration (hours)							
	1	2	4	8	24	72	168	240
3	2.60	3.20	3.80	4.48	6.00	7.60	9.50	10.80
10	3.20	4.00	4.80	5.84	7.92	8.90	11.00	12.50
25	3.60	4.40	5.28	6.56	8.64	11.00	13.00	15.00
100	4.40	5.40	6.72	8.00	11.04	13.80	16.00	18.00

1-HOUR DURATION

T(hrs)	P/ P_{total}	I/ P_{total}
0	0	0
.1	.020	.200
.2	.080	.600
.3	.200	1.200
.4	.410	2.100
.5	.625	2.150
.6	.805	1.800
.7	.915	1.100
.8	.985	0.700
.9	.995	0.100
1.0	1.000	0

¹ Values for durations through 24 hours were taken from Florida Department of Transportation intensity curves. Values for durations greater than 24 hours were taken from National Weather Service Technical Paper No. 49, 1964.

1-Hour Duration Mass Rainfall Curve

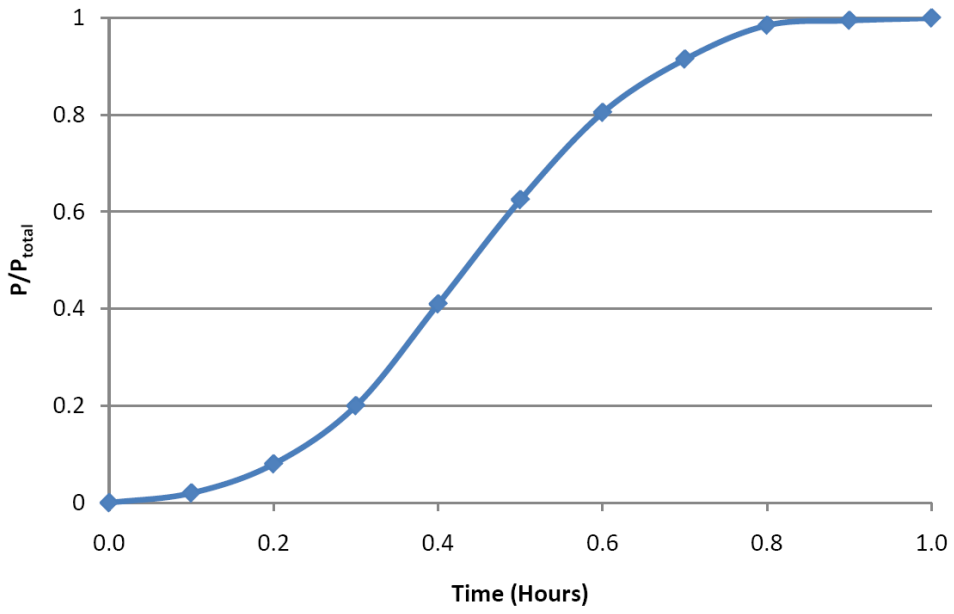

1-Hour Duration Intensity Curve

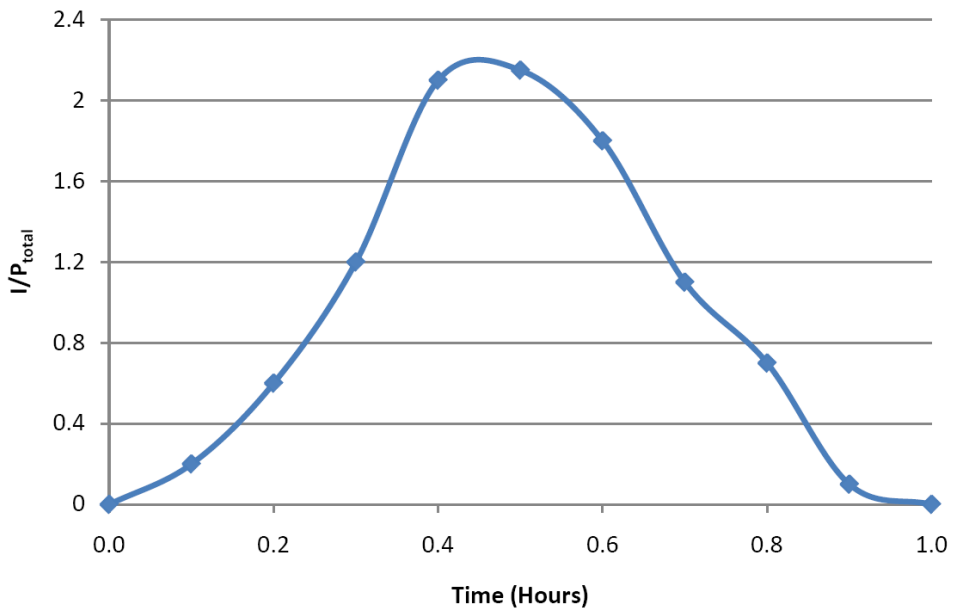

2-HOUR DURATION

T(hrs)	P/P _{total}	I/P _{total}
0	0	0
.2	.100	.500
.4	.250	.750
.6	.450	1.000
.8	.700	1.250
1.0	.800	.500
1.2	.860	.300
1.4	.910	.250
1.6	.950	.200
1.8	.980	.150
2.0	1.000	0

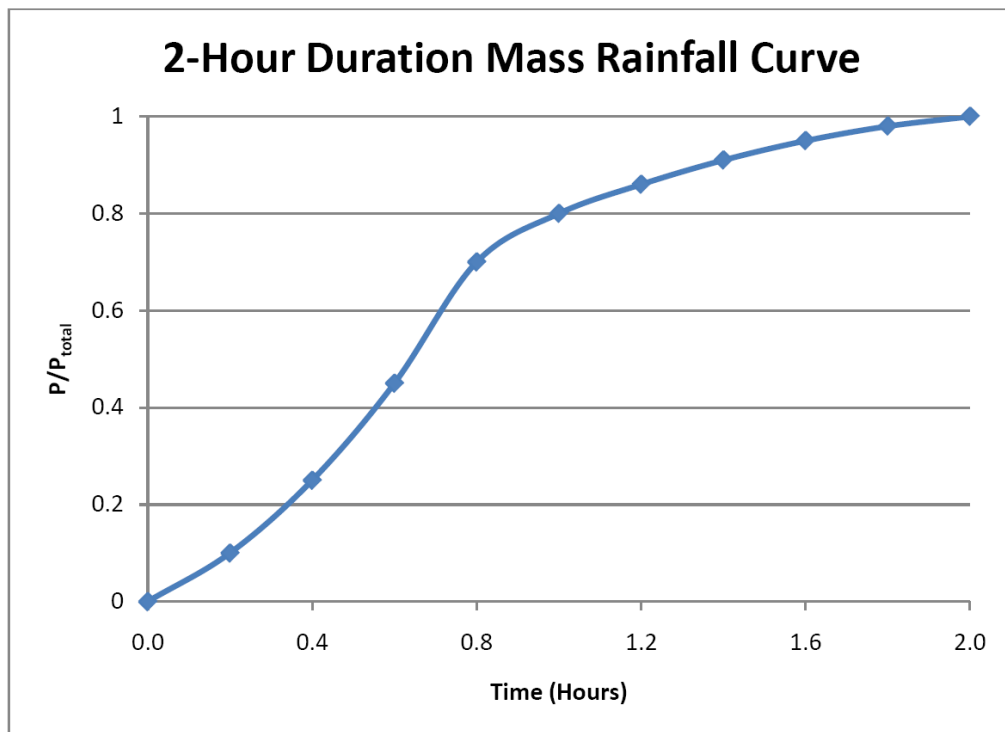

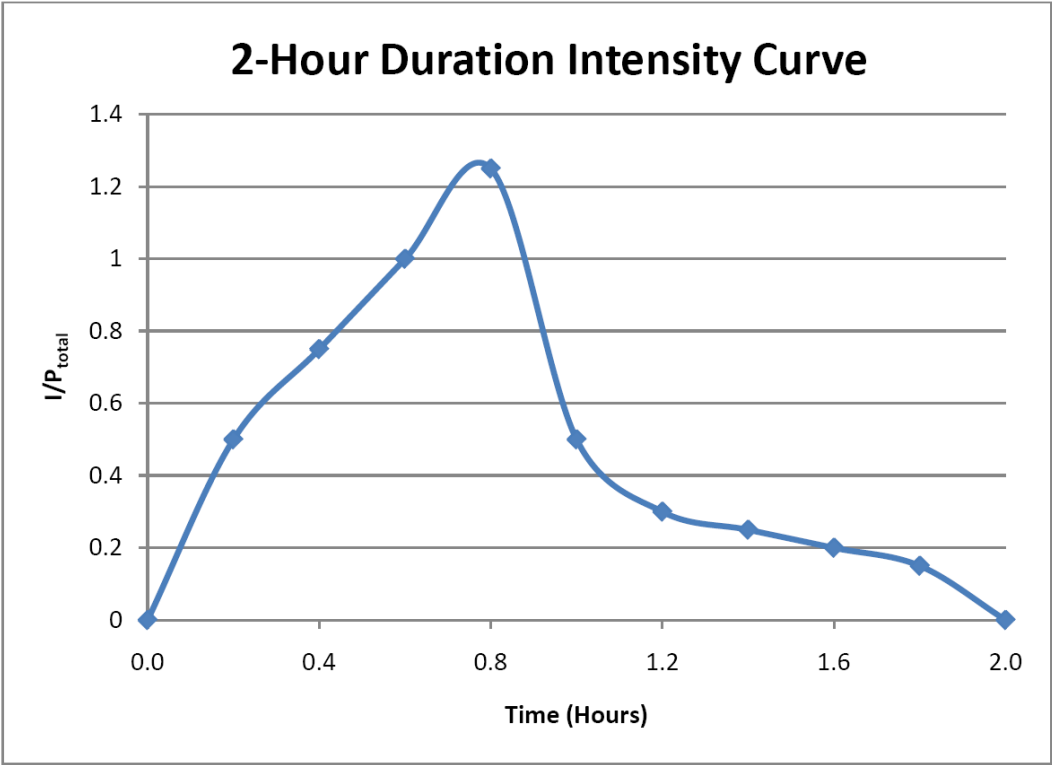

4-HOUR DURATION

T(hrs)	P/P _{total}	I/P _{total}
0	0	0
0.5	0.040	0.080
1.0	0.140	0.200
1.5	0.320	0.360
2.0	0.580	0.520
2.5	0.790	0.420
3.0	0.930	0.280
3.5	0.980	0.100
4.0	1.000	0

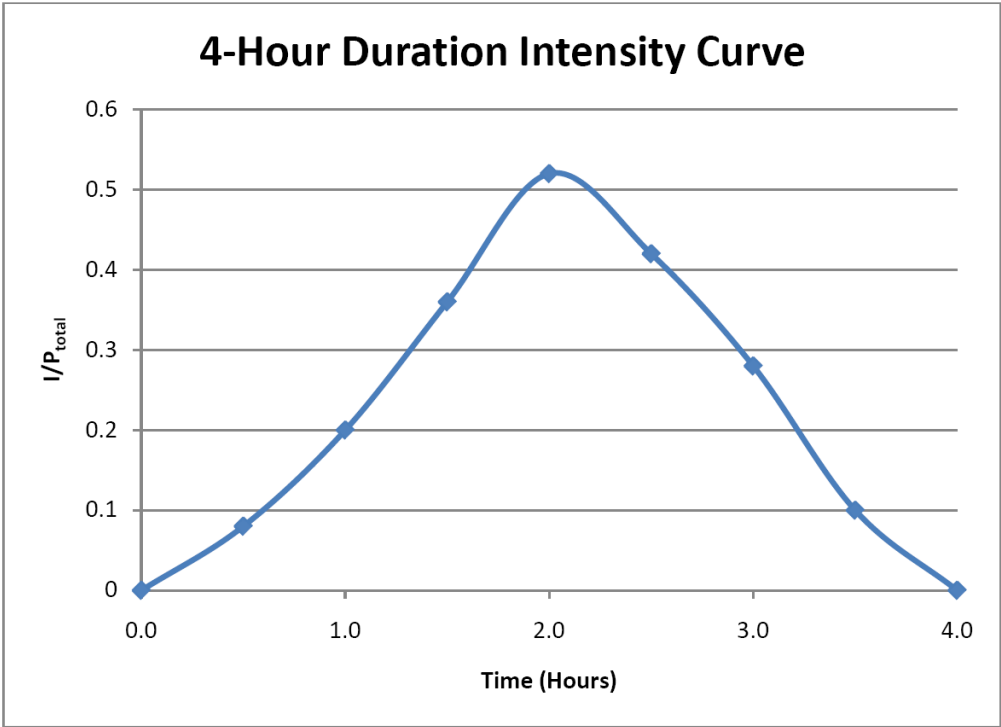
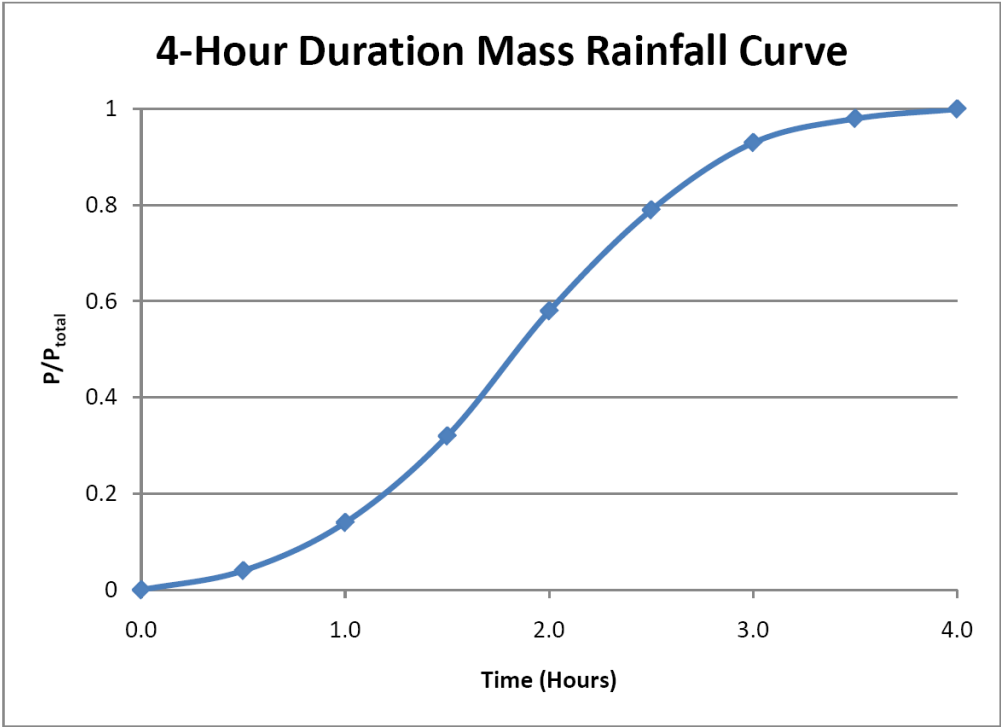

8-HOUR DURATION

T(hrs)	P/P _{total}	I/P _{total}
1	.020	.020
2	.130	.060
3	.280	.150
4	.700	.420
5	.860	.160
6	.920	.060
7	.970	.050
8	1.000	0

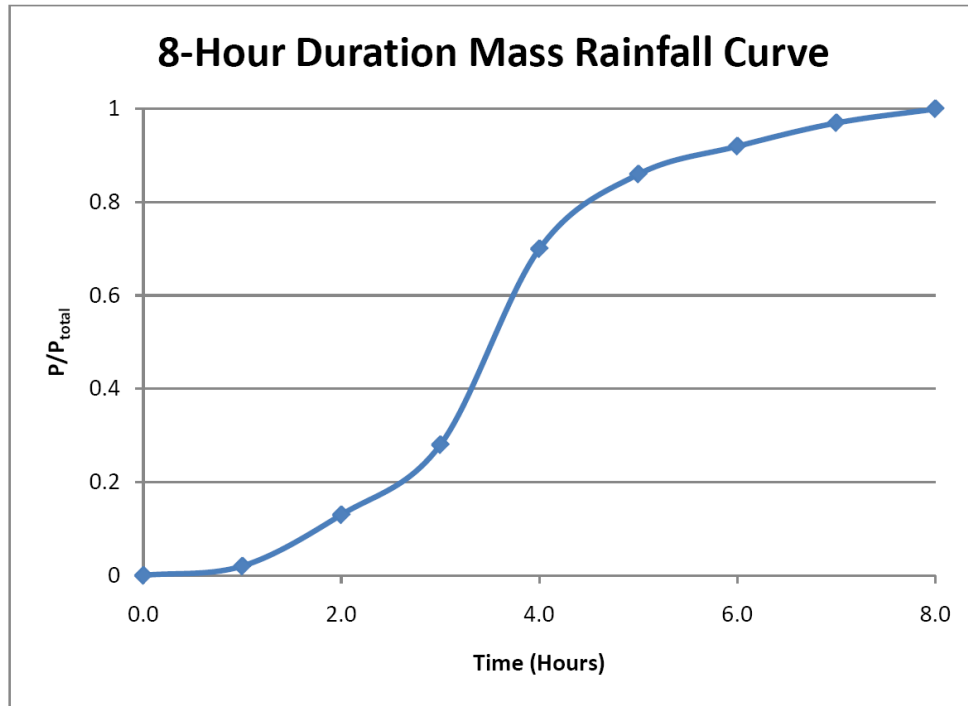

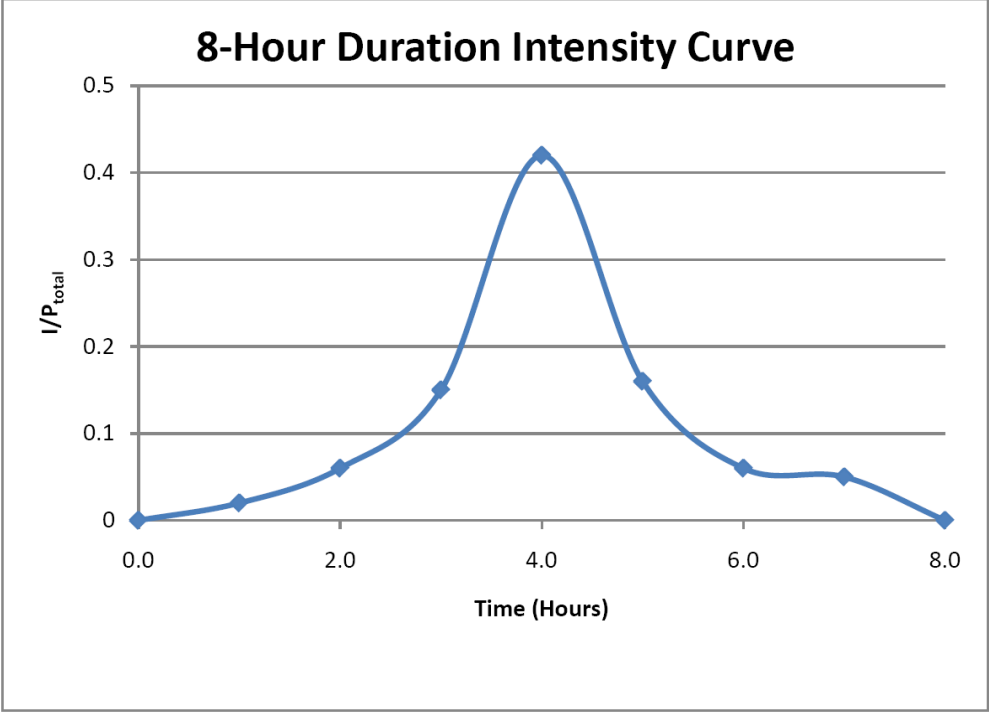

24-HOUR DURATION

T(hrs)	P/P _{total}	I/P _{total}
0	0	0
1	.010	.010
2	.030	.020
3	.060	.030
4	.090	.030
5	.120	.030
6	.160	.040
7	.200	.040
8	.240	.040
9	.300	.060
10	.360	.060
11	.440	.080
12	.540	.100
13	.610	.070
14	.670	.060
15	.730	.060
16	.780	.050
17	.820	.040
18	.860	.040
19	.900	.040
20	.930	.030
21	.960	.030
22	.980	.020
23	.990	.010
24	1.000	0

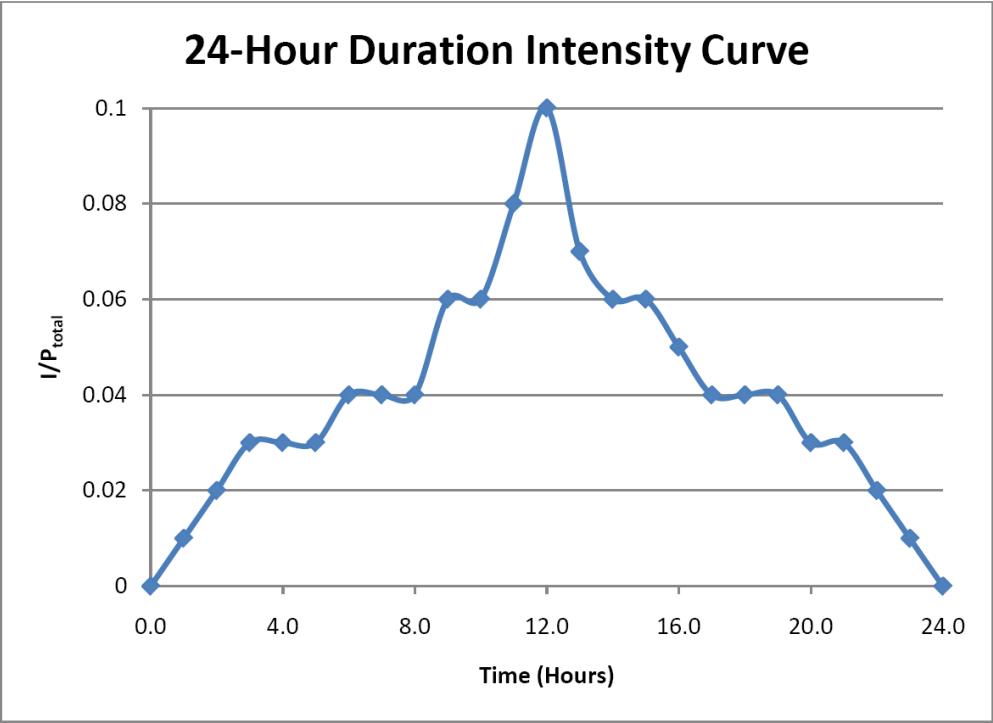
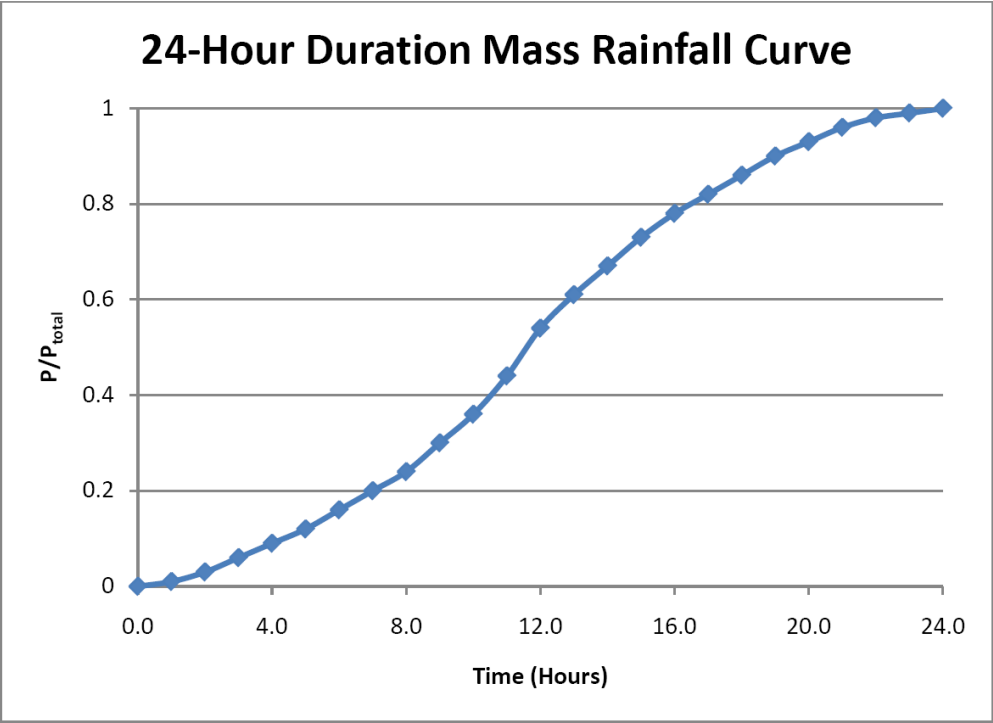

3-DAY DURATION

T(hrs)	P/P _{total}	I/P _{total}
0	0	0
4	.010	.003
8	.045	.009
12	.155	.028
16	.218	.016
20	.240	.006
24	.250	.003
28	.268	.005
32	.304	.009
36	.436	.033
40	.511	.019
44	.538	.007
48	.550	.003
52	.577	.007
56	.631	.014
60	.829	.050
64	.942	.028
68	.982	.010
72	1.000	0

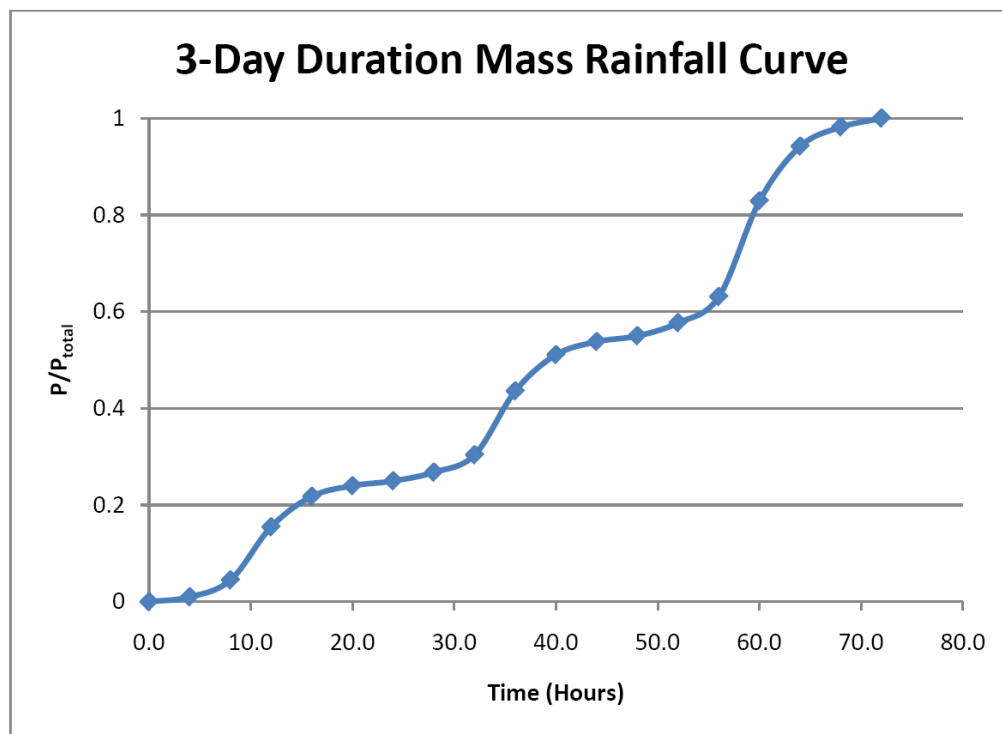

3-Day Duration Intensity Curve

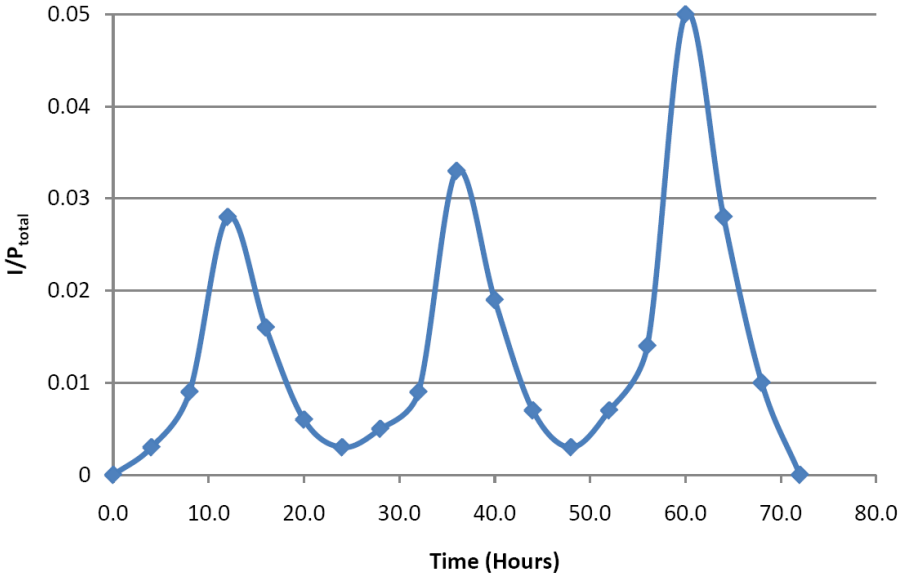

7-DAY DURATION

T(hrs)	P/P _{total}	I/P _{total}
0	0	0
8	.027	.003
16	.053	.003
24	.080	.003
32	.116	.005
40	.254	.017
48	.280	.003
56	.320	.005
64	.360	.005
72	.400	.005
80	.413	.002
88	.427	.002
96	.440	.002
104	.460	.003
112	.480	.003
120	.500	.003
128	.553	.007
136	.607	.007
144	.660	.007
152	.721	.008
160	.956	.029
168	1.000	0

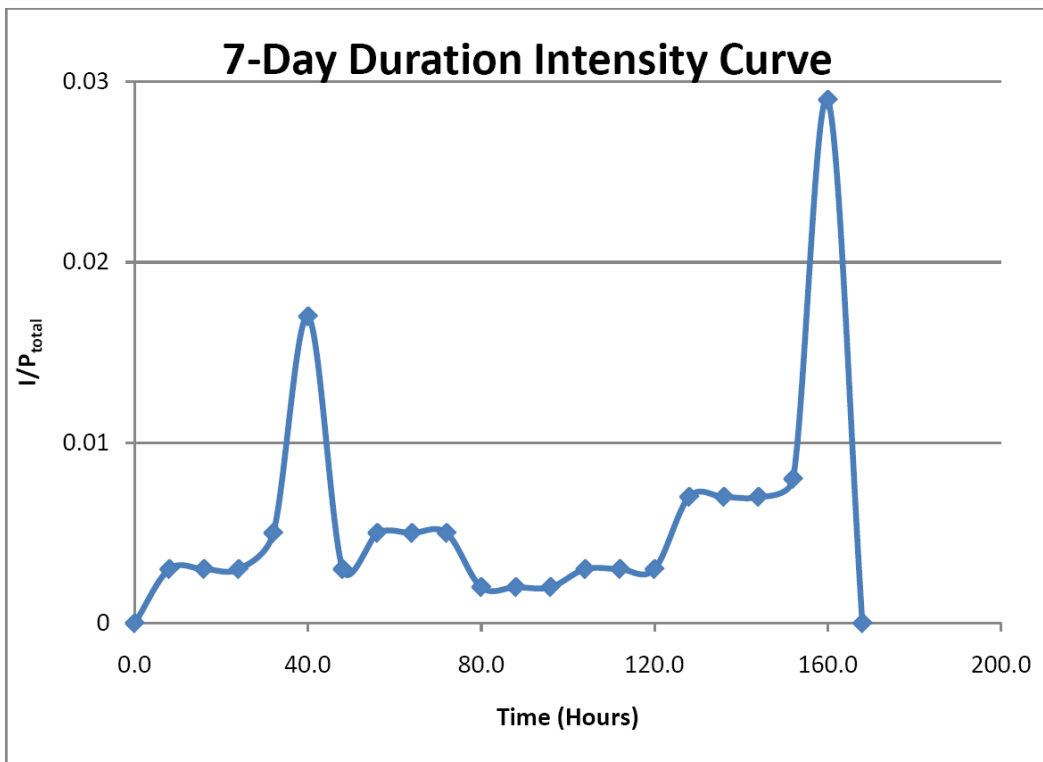
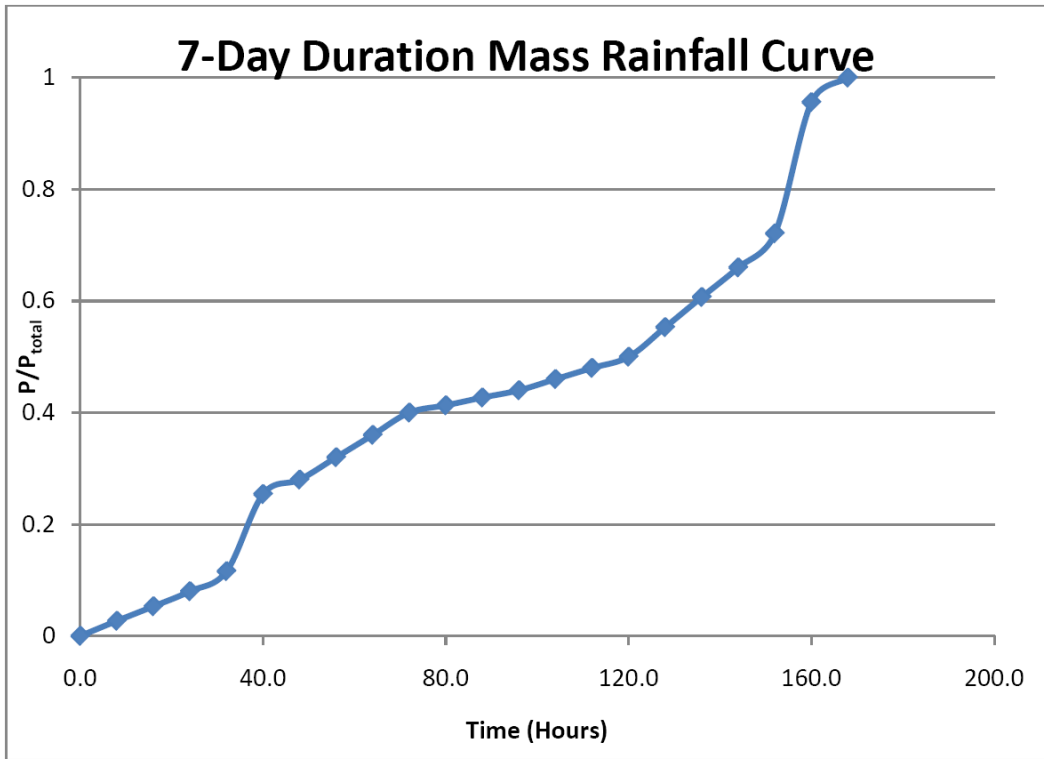

10-DAY DURATION

T(hrs)	P/P _{total}	I/P _{total}
0	0	0
8	.013	.002
16	.027	.002
24	.040	.002
32	.080	.005
40	.229	.019
48	.260	.004
56	.287	.003
64	.313	.003
72	.340	.003
80	.347	.001
88	.353	.001
96	.360	.001
104	.367	.001
112	.373	.001
120	.380	.001
128	.387	.001
136	.393	.001
144	.400	.001
152	.420	.003
160	.440	.003
168	.460	.003
176	.532	.009
184	.808	.035
192	.860	.007
200	.893	.004
208	.926	.004
216	.960	.004
224	.973	.002
232	.986	.002
240	1.000	0

10-Day Duration Mass Rainfall Curve

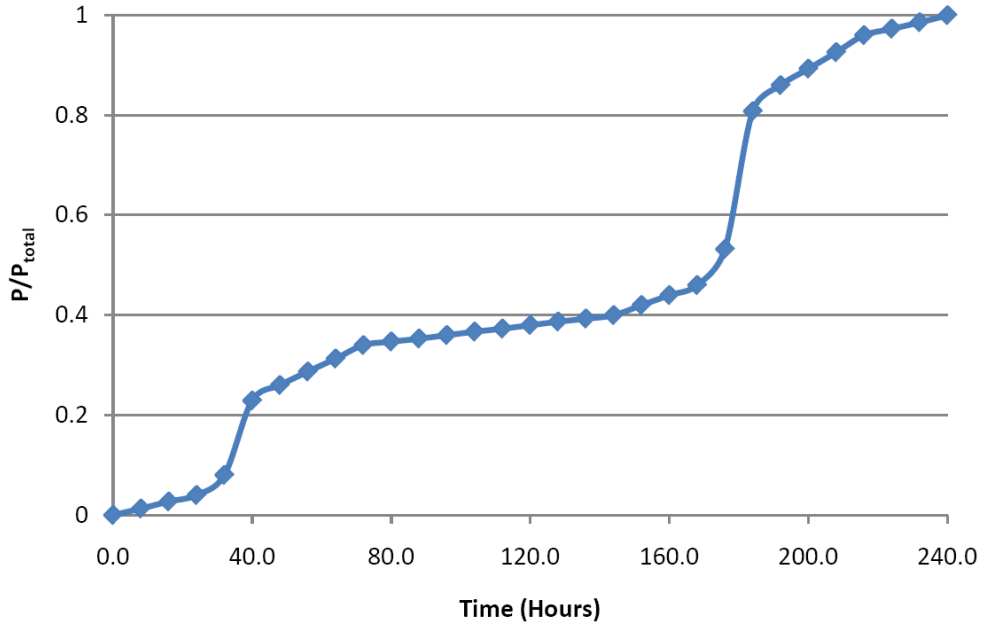

10-Day Duration Intensity Curve

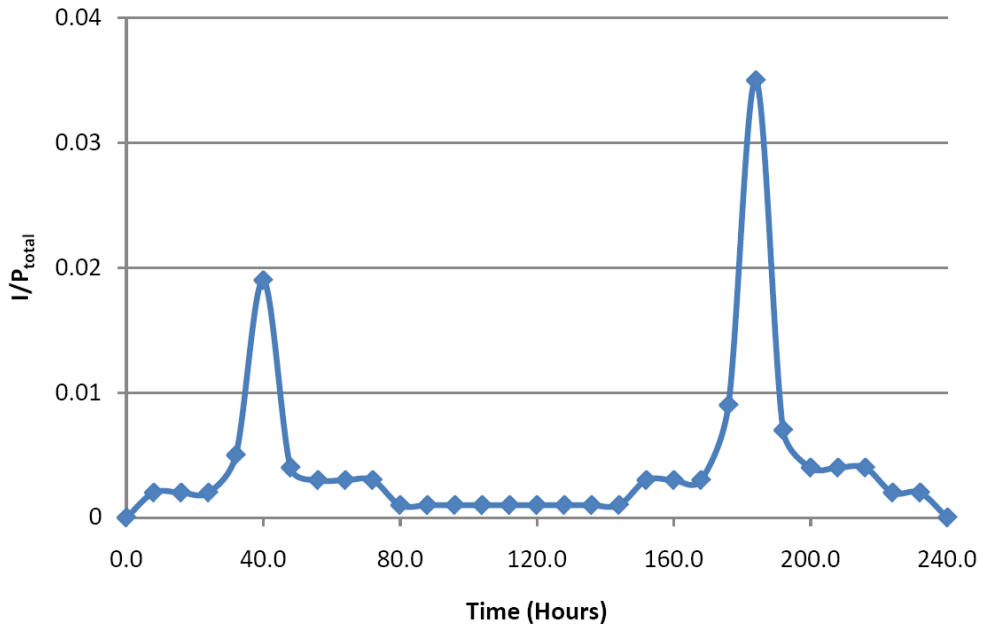

NAME OF PERSON ORIGINATING PROPOSED RULE: Tim Sagul, Director, Resource Management, Suwannee River Water Management District, 9225 County Road 49, Live Oak, Florida 32060, (386)362-1001.

NAME OF SUPERVISOR OR PERSON WHO APPROVED THE PROPOSED RULE: Governing Board of the Suwannee River Water Management District.

DATE PROPOSED RULE APPROVED: November 15, 2012.

DATE NOTICE OF PROPOSED RULE DEVELOPMENT PUBLISHED IN FAW: