

**SOUTHWEST FLORIDA WATER MANAGEMENT
DISTRICT**

**ENVIRONMENTAL RESOURCE PERMIT
APPLICANT'S HANDBOOK**

VOLUME II

**DESIGN REQUIREMENTS FOR
STORMWATER TREATMENT AND MANAGEMENT SYSTEMS
WATER QUALITY AND WATER QUANTITY**

**FOR USE WITHIN THE GEOGRAPHIC LIMITS OF THE SOUTHWEST FLORIDA
WATER MANAGEMENT DISTRICT**

EFFECTIVE June 1, 2018



Volume II is incorporated by reference in 40D-1.660, F.A.C.

TABLE OF CONTENTS

PART I – INTRODUCTION, ORGANIZATION, APPLICABILITY.....	1
1.0 INTRODUCTION	1
1.1 Objectives	2
1.2 Thresholds	3
1.3 District-Specific Exemptions	3
1.3.1 Agricultural Exemption Determinations Available Through the District’s Agricultural Ground and Surface Water Management System Program.....	4
1.3.2 Process for Obtaining Agricultural Exemptions.....	4
1.4 Criteria and Flexibility.....	5
1.5 Simultaneous Reviews.....	6
PART II – GENERAL CRITERIA.....	7
2.0 GENERAL DESIGN AND PERFORMANCE CRITERIA FOR ALL STORMWATER MANAGEMENT SYSTEMS	7
2.1 Definitions and Terms	7
2.2 Professional Certification	9
2.3 Tailwater Considerations	9
2.3.1 Tailwater for Water Quality Design.....	10
2.3.2 Tailwater for Water Quantity Design	10
2.3.3 Regulated Systems	10
2.4 Retrofits of Existing Stormwater Management Systems	10
a. Stormwater Retrofits.....	10
b. Stormwater Quality Retrofits.....	11
c. Stormwater Quantity (Flood Control) Retrofits.....	11
2.5 District Drainage Basins and Watersheds	12
2.6 Flexibility in State Transportation Projects and Facilities	12
Figure 2.5 Drainage Basins and Watersheds within the SWFWMD.....	14
2.7 Inspections to Ensure Proper Operation and Maintenance.....	13
PART III – STORMWATER QUANTITY/FLOOD CONTROL	15
3.0 GENERAL STORMWATER QUANTITY AND FLOOD CONTROL REQUIREMENTS	15
3.1 Discharges	15
3.2 Flood Protection.....	16
3.3 Flood Plain Encroachment.....	17
3.4 100-Year Flood Level Determinations	17
3.5 Minimum Drainage	18
3.6 Water Conservation, Low Flow and Base Flow Maintenance	18
3.6.1 Minimum Flows and Levels	18
3.6.2 Water Withdrawals	19
3.7 Historic Basin Storage	19
3.8 Off-site Lands.....	19
3.9 Isolated Wetlands	19
3.10 Rural or Minor Subdivisions.....	19

PART IV – STORMWATER QUALITY..... 20

4.0 PURPOSE..... 20

- 4.1 Retention and Detention Criteria 20
 - a. Wet Detention Systems 20
 - b. Detention with Effluent Filtration System (Manmade Underdrains) 21
 - c. On-line Retention Treatment Systems..... 22
 - d. Off-line Retention Treatment Systems..... 22
 - e. Underground Exfiltration Treatment Systems 23
 - f. Discharges to Outstanding Florida Waters 23
 - g. Where Ambient Water Quality Does Not Meet Standards 23
 - h. Off-Site Treatment Volumes 24
- 4.2 Public Supply Wells 24
- 4.3 Sewage Treatment Percolation Ponds 24
- 4.4 Solid Waste Facilities 24
- 4.5 Alterations to Existing Public Roadway Projects 24
- 4.6 Water Quality Monitoring 25
- 4.7 General and Special Conditions Related to Water Quality Monitoring by Permittees..... 25
- 4.8 Compensating Stormwater Treatment..... 26
 - 4.8.1 Overtreatment..... 26
 - 4.8.2 Off-site Compensation..... 27
- 4.9 Rural or Minor Subdivisions 27

PART V – CONSTRUCTION DESIGN REQUIREMENTS..... 28

5.0 DESIGN CRITERIA 28

- 5.1 Discharge Structures 28
- 5.2 Control Devices/Bleed-Down Mechanisms for Detention Systems 29
- 5.3 Maintenance Considerations 29
- 5.4 Retention and Detention Areas 29
 - 5.4.1 Dimensional Criteria (as measured at or from the control elevation)..... 29
 - 5.4.2 Maintenance Access 30
- 5.5 Exfiltration Systems Dimensional Criteria..... 30
- 5.6 Management of Runoff for Impervious and Semi-Impervious Areas..... 30
- 5.7 Stagnant Water Conditions 30
- 5.8 Sediment Sumps..... 31
- 5.9 Dam Safety 31
- 5.10 Rural or Minor Residential Subdivisions..... 31
- 5.11 Sensitive Karst Areas..... 32

PART VI – DESIGN INFORMATION..... 34

6.0 DESIGN CRITERIA 34

- 6.1 Antecedent Conditions..... 34
- 6.2 Rainfall Volume 34
- 6.3 Rainfall Distribution 34
- 6.4 Open Surface Storage 34
- 6.5 Ground Surface Infiltration 34
- 6.6 Subsurface Exfiltration 35
- 6.7 Runoff 35
- 6.8 Allowable Discharges..... 35

APPENDICES36

PART I – INTRODUCTION, ORGANIZATION, APPLICABILITY

1.0 Introduction

To assist applicants seeking Environmental Resource Permits (ERPs), an Applicant's Handbook has been prepared as part of the overall effort to promote greater statewide consistency in the administration of Chapter 62-330, Florida Administrative Code (F.A.C.). The ERP Applicant's Handbook is presented in two volumes. **Applicant's Handbook Volume I** (General and Environmental), is applicable statewide and contains the following:

- Background information on the ERP program, including points of contact;
- A summary of the statutes and rules that are used to authorize and implement the ERP program;
- A summary of the types of permits, permit thresholds, and exemptions;
- A discussion of the environmental criteria used for ERP evaluations;
- A discussion of the erosion and sediment control requirements for ERP projects, and
- A discussion of requirements for system operation and maintenance.

Each Water Management District has adopted an ERP Applicant's Handbook Volume II ("Volume II") which contains the District-specific design and performance criteria for stormwater quantity, flood control, stormwater quality and any special basin criteria or other requirements that are applicable within the geographic area of the specific water management district. This Volume II (Design Requirements for Stormwater Treatment and Management Systems – Water Quality and Water Quantity) is intended for use only within the jurisdictional boundaries of the Southwest Florida Water Management District.

Together, Applicant's Handbook Volumes I and II set forth the usual procedures and information used by District staff in the review of permit applications. The overall objective of the review is to ensure that the activities authorized by an ERP are not harmful to the water resources of the District and not inconsistent with the public interest or the overall objectives of the District.

This Volume II is intended to be applicable to those types of projects that involve stormwater management systems that consist of more than just incidental dredging or filling and which require an individual permit or authorization pursuant to Section 403.814(12), F.S. ("10-2 Permits."). Many minor "stand-alone" activities or works generally will not give rise to water quantity, flood control or water quality concerns that must be addressed in accordance with the performance standards and design criteria set forth in this Volume II. However, if a project requires consideration of water quantity, water quality or flood impacts and specific measures or design features in order to demonstrate reasonable assurance that all required conditions for permit issuance have been met, Volume II will be applicable.

Volume II provides specific, detailed information to help applicants meet the water quality, water quantity, flood control, construction and design requirements applicable within this District. It is

incorporated by reference in Rule 40D-1.660, F.A.C., as well as in Rule 62-330.010, F.A.C., and, as such, Volume II constitutes rules of the District and DEP. The term “Agency” or “District,” when used in the Applicant’s Handbook Volumes I or II, or in Chapter 62-330, F.A.C., refers to the DEP, this District, all Water Management Districts or a delegated local government, as applicable, in accordance with the division of responsibilities specified in the Operating Agreements as discussed in subsection 62-330.010(3), F.A.C., except where a specific agency is otherwise identified. The Applicant’s Handbook Volumes I and II are written to provide more detail and clarity for the public in understanding the statutory and rule provisions that implement the ERP program, and are intended to be written in an understandable, “user-friendly” format.

Pursuant to Subsection 373.4131(1)(c), F.S., the statewide ERP rules set forth in Chapter 62-330, F.A.C., are to rely primarily on the rules of the DEP and water management districts in effect immediately prior to the effective date of the new statewide rules. Accordingly, history notes are provided for the various sections and paragraphs of this Volume II to identify the source of the particular provision as being the District’s Environmental Resource Permitting Information Manual Part B, Basis of Review (BOR) (effective date 12/29/2011) or in some cases the Northwest Florida Water Management District (NFWWMD) Applicant’s Handbook Volume I or Volume II (effective date 11/20/2010) or other source as applicable. Most of the provisions of this Volume II contain material transferred directly from Chapters 1, 3 through 6 of the District’s ERP BOR, with no substantive changes or only minimal changes as needed for standardized formatting or to reference related provisions in Chapter 62-330, F.A.C., or in Volume I. To promote a more consistent statewide approach, the NFWWMD Applicant’s Handbook, drafted and adopted by DEP for use within that District, served as the model for the development of the Applicant’s Handbook Volumes I and II. Where appropriate, some provisions contained in NFWWMD’s Applicant’s Handbook that described the same practice or approach used in this District for addressing water quality, water quantity or flood control requirements are included in this Volume II. Additional provisions are also added pursuant to guidance from DEP, to promote statewide consistency.

History Note: Adapted from NFWWMD Applicant’s Handbook Volume II, Part I.

1.1 Objectives.

Pursuant to Part IV of Chapter 373, F.S., and Chapter 62-330, F.A.C., the District is responsible for permitting the construction, alteration, operation, maintenance, repair, abandonment or removal of surface water management systems within its jurisdictional boundaries, in accordance with its Operating Agreement with DEP. A copy of the Operating Agreement is included in the Appendix for reference. The objective of this Applicant’s Handbook Volumes I and II is to identify the usual procedures and information used by the District in permit application review. The objective of the review is to ensure that the permit will authorize activities or situations which are not harmful to the water resources of the District nor inconsistent with the public interest or the overall objectives of the District.

History Note: Transferred from SWFWMD Environmental Resource Permitting Information Manual, Part B, Basis of Review, section 1.1.

1.2 Thresholds.

Thresholds for permitting are set forth in subsection 62-330.020(2), F.A.C., and apply statewide. There are currently no additional District-specific thresholds applicable within this District. If any are established in the future, they will be set forth in this section.

History Note: New 10-1-13

1.3 District-Specific Exemptions.

In addition to the exemptions set forth in Section 62-330.051, F.A.C., the specific activities described below are exempt from the requirement to obtain an ERP in this District:

(1) The operation and maintenance of a surface water management system which:
(a) Was constructed before October 1, 1984; or
(b) Was constructed or was being constructed on or before December 9, 1999, and was not required to obtain a District permit under exemptions existing at the time.

(2) The following mining activities:
(a) Any system for a mining or mining related activity which has a valid permit issued by the District or the Department pursuant to Rule 40D-45.041, F.A.C. This exemption shall be for the plans, terms and conditions approved in the permit issued pursuant to Chapter 40D-45, F.A.C. If an operator of a system previously permitted under Chapter 40D-45, F.A.C., proposes to alter such system, the alteration shall be reviewed under the provisions of Chapter 62-330, F.A.C.

(b) Phosphate mining, phosphate mining related surface water management systems, and reclamation and restoration conducted in accordance with Chapter 62C-16, F.A.C., within the District, provided that all the following conditions are met.

1. Activities associated with mining operations as defined by and subject to Sections 378.201 through .212, F.S., and included in a conceptual reclamation plan or modification application submitted prior to July 1, 1996, shall continue to be exempt under this subsection.

2. The location of any existing point of discharge authorized in a previous permit issued by the Department, the Department of Environmental Regulation, or the District shall not be changed, and the volume and frequency of such discharge shall not be exceeded.

3. Natural drainage from off-site up gradient areas shall not be interrupted so as to cause damage to off-site property or the public, and natural drainage patterns on undisturbed lands shall be maintained to the maximum extent achievable without adversely altering the time, stage, volume and point or manner of discharge or dispersion.

(3) Proposed normal and necessary farming operations as are customary for the area that can be conducted in an environmentally sustainable manner, provided such operations and facilities:

(a) Do not cause adverse water quantity or offsite flooding impacts;
(b) Do not involve activities in wetlands or other surface waters for which mitigation would be required; and
(c) Do not adversely impact water quality in offsite receiving waters.

Persons desiring to qualify for this exemption should submit site drainage and conservation plans for the proposed normal and necessary farming operations which incorporate Natural Resource

Conservation Service, Florida Department of Agriculture and Consumer Services, or equivalent conservation standards or best management practices in accordance with Section 1.3.2 below. Following a meeting with District agricultural regulatory staff and verification that the operations, facilities, and plans comply with paragraphs (a) through (c), above, the District will provide written notice of the exemption, if qualified.

History note: (1) formerly 40D-4.051(2); (2) formerly 40D-4.051(5) and 40D-4.053; and (3) formerly 40D-4.051(4) with amendments; F.A.C.

1.3.1 Agricultural Exemption Determinations Available Through the District's Agricultural Ground and Surface Water Management System Program.

Historically, the construction, alteration, operation, maintenance (excluding routine custodial maintenance), abandonment or removal of agricultural surface water management systems has required an Environmental Resource Permit (ERP) unless expressly exempt by statute or rule. Many agricultural operations are exempt pursuant to the statutory exemption set forth in subsection 373.406(2), F.S. Additionally, since 1990, the District has implemented a rule-specific agricultural exemption formerly expressed in subsection 40D-4.051(4), F.A.C., an updated version of which is now set forth in Volume II Section 1.3(3) above. This exemption provision has been updated to align with amendments to the statutory agricultural exemption that became effective July 1, 2011. For many years the District has also provided services and resources to assist farmers and other agriculturalists in meeting environmental and agricultural design requirements through incentive-based and ecosystem-based resource management practices. These services and exemption determinations continue to be provided through the District's Agricultural Ground and Surface Water Management System (AGSWM) program, which promotes voluntary implementation of best management practices (BMPs) and other environmentally beneficial farming principles as a passive alternative to environmental resource permitting.

The District's AGSWM program relies upon technical assistance available from the United States Department of Agriculture Natural Resources Conservation Service (NRCS) that encourages agriculturalists to use resource management system (RMS) conservation planning and to practice good water management. The NRCS specializes in RMS conservation planning, which may provide farmers with a viable alternative to the usual permitting procedures. The District's Ag Team, which consists of professional engineering and environmental staff who specialize in agricultural operations, is available to offer assistance to farmers seeking either verification of exemption from ERP requirements or other on-site review and guidance regarding sustainable agricultural practices. Conservation planning techniques of the NRCS further complement District Ag Team efforts to help facilitate surface water and water use regulation (permitting or exemption) for qualifying agricultural projects.

1.3.2 Process for Obtaining Agricultural Exemptions.

The District will continue to provide confirmation of qualification of exemption from permitting through the District's voluntary AGSWM program for farmers desiring to avail themselves of the District's specific agricultural-related exemption, as well as confirmation of exemption pursuant to the statutory exemption set forth in subsection 373.406(2), F.S., and any other applicable statutory or rule exemption for agricultural activities. Written requests for verification of exemption must comply with the requirements of section 62-330.050, F.A.C., and must include the fee specified in section 40D-1.607, F.A.C.

Farmers seeking an agricultural exemption determination are encouraged to contact the District's Ag Team as a first step. The District's Ag Team is based in the Tampa Permitting Office and is available for meetings in any of the District's service offices. Persons desiring to qualify for the exemption set forth in section 1.3(3) above will be expected to submit appropriate site-specific drainage and conservation plans for the proposed operations and demonstrate adherence to applicable nutrient, pest, drainage, irrigation or other conservation standards and BMPs that are adopted or recognized by NRCS, the Florida Department of Agriculture and Consumer Services (FDACS), or other equivalent source. The grower may contact the NRCS to obtain a federally prescribed RMS plan of site-specific BMPs that may be used as part of the District's agricultural exemption confirmation process. The local NRCS office for specific regions may be found at the NRCS website. DACS' Office of Agricultural Water Policy also has adopted by rule certain statewide BMP manuals for major commodity crops such as citrus, container nurseries, cow/calf operations, sod, vegetable and agronomic crops, and specialty fruit and nut crops. Implementation of the FDACS-prescribed BMPs provides a presumption of compliance with statewide water quality discharge standards. The FDACS-adopted BMPs and manuals can also be found at the NRCS website.

Following an on-site meeting with District agricultural regulatory staff, review of submitted material and confirmation that the proposed operations, facilities, and plans will comply with the provisions of section 1.3(3) above, the District will provide written notice of verification of exemption.

Exemption from permitting for agricultural activities is also established pursuant to subsection 373.406(2), F.S., (known as the statutory agricultural exemption). This provision allows persons engaged in the occupation of agriculture, silviculture, floriculture or horticulture to alter the topography of any tract of land, including but not limited to activities that may impede or divert the flow of surface waters or adversely impact wetlands, for purposes consistent with the normal and customary practice of such occupation in the area; provided that such alteration is not for the sole or predominant purpose of impeding or diverting the flow of surface waters or adversely impacting wetlands. This exemption applies to lands classified as agricultural pursuant to section 193.461, F.S., and to activities requiring an ERP pursuant to Part IV of Chapter 373, F.S. This exemption does not apply to any activities previously authorized by an ERP or a management and storage of surface waters permit issued pursuant to Part IV of Chapter 373, F.S., or a dredge and fill permit issued pursuant to Chapter 403, F.S. While a District determination of exemption from permitting on the basis of this statutory exemption is not required in order for such activities to be exempt, the AGSWM program can be used to obtain District verification of this exemption.

1.4 Criteria and Flexibility.

The criteria contained in this Volume II were established with the primary goal of meeting District water resource objectives as set forth in Chapter 373, F.S. Performance criteria are used where possible. However, the criteria set forth in this Volume II are designed to be flexible. Other methods of meeting the overall objectives and the conditions for issuance set forth in Rules 62-330.301 and 62-330.302, F.A.C., will be considered depending on the magnitude of specific or cumulative impacts. Reasonable assurance in the form of plans, test results, or other information must be provided by the applicant to demonstrate that the alternative design meets the conditions for permit issuance.

Compliance with the criteria herein constitutes a presumption that the proposed activity is in conformance with the conditions for issuance set forth in Rules 62-330.301 and 62-330.302, F.A.C. Pursuant to Section 373.4131, F.S., if a stormwater management system is designed in

accordance with the criteria in this Volume II or if a system is constructed, operated and maintained for stormwater treatment in accordance with a valid Environmental Resource Permit or exemption under Part IV of Chapter 373, F.S., the discharges from the system are presumed not to violate applicable state water quality standards.

History Note: Transferred from SWFWMD Environmental Resource Permitting Information Manual, Part B, Basis of Review, section 1.3.

1.5 Simultaneous Reviews.

Applicants seeking an Environmental Resource Permit typically will also need to obtain additional permits or approvals from other agencies and may have to comply with other legal or regulatory constraints. Because of the time requirements for processing permits, it is advisable for the applicant to contact other interested agencies, organizations, and affected citizens prior to submitting a formal application to the District. Summaries of meetings and copies of responses from appropriate parties should be included in the application.

It may be in the applicant's best interest to seek simultaneous reviews from all agencies with jurisdiction over the proposed activity. This provision is not intended to preclude the submission of an application to this District prior to receiving other necessary approvals. However, coordinating the review of this application with all appropriate agencies of local government will help ensure that the final design approved by the District meets the requirements of all agencies. Applicants should note the possibility that additional requirements from agencies of local government not contained within the final approved design may necessitate a permit modification.

Issuance of an Environmental Resource Permit by the District does not relieve the applicant of the responsibility to obtain all necessary federal, state, local or special district permits or authorizations.

History Note: Transferred from SWFWMD ERP Information Manual Part B, Basis of Review, Section 1.4, with amendments.

PART II — GENERAL CRITERIA

2.0 General Design and Performance Criteria for all Stormwater Management Systems.

This Volume II applies to the design of stormwater management systems that require a permit under Chapter 62-330, F.A.C., other than systems that qualify for a general permit, and applies to the design of projects that qualify for a "10/2" permit. All stormwater management systems must be designed, constructed, operated and maintained in accordance with the stormwater quality criteria and stormwater quantity/flood control criteria set forth in this Volume II.

History Note: Adapted from NFWFMD AH II, sections 2.0 and 2.1.

2.1 Definitions and Terms.

The following terms are addressed in this Volume II and apply within the Southwest Florida Water Management District. These terms are in addition to the definitions and terms that apply statewide and which are provided in Applicant's Handbook Volume I or in Chapter 62-330, F.A.C., or applicable statutes:

2.1.1 "Aquitard"

A tightly compacted soil structure that retards but does not prevent flow of water to or from an adjacent aquifer. It does not allow water to pass through it fast enough to be used as a water supply, but if breached, could allow mixing of water sources between adjacent aquifers.

2.1.2 "Closed Drainage Basin"

A drainage basin in which the runoff does not have a surface outfall up to and including the 100-year flood level.

2.1.3 "Control Device"

The element of a discharge structure which allows the gradual release of water under controlled conditions. This is sometimes referred to as the bleed-down mechanism or "bleeder." Examples include orifices, notches, weirs, and effluent filtration systems.

2.1.4 "Control Elevation"

The lowest elevation at which water can be released through the control device. This is sometimes referred to as the invert elevation.

2.1.5 "Detention"

The delay of storm runoff prior to discharge into receiving waters.

2.1.6 "Detention Volume"

The volume of open surface storage behind the discharge structure measured between the overflow elevation and control elevation.

2.1.7 "Directly Connected Impervious Areas"

Unless otherwise specifically stated in this Volume II, directly connected impervious areas as considered in the calculation of volumes for treatment systems are those impervious and semi-impervious areas hydraulically connected to the treatment system directly or by pipes or ditches.

2.1.8 "Discharge Structure"

A structural device, usually of concrete, metal, etc., through which water is discharged from a project to the receiving water.

2.1.9 "Drainage Basin"

A subdivision of a watershed. A map showing District drainage basins is provided as Figure 2.6.

2.1.10 "Elevation"

The height in feet above mean sea level according to the appropriate established vertical data, such as North American Vertical Datum (NAVD) or National Geodetic Vertical Datum (NGVD).

2.1.11 "Historic Basin Storage"

The depression storage available on the site in the pre-development condition. The volume of storage is that which exists up to the required design storm.

2.1.12 "Historic Discharge"

The peak rate and/or amount of runoff which leaves a parcel of land by gravity from an undisturbed/existing site, or the legally allowable discharge at the time of permit application.

2.1.13 "Hydroperiod"

The duration of inundation in a wetland.

2.1.14 "Normal Water Level"

The design starting water elevation used when determining stage/storage design computations in a retention or detention area. A retention or detention system may have two (2) designated "normal water levels" associated with it if the system is designed for both water quality and water quantity.

2.1.15 "Off-line Treatment System"

A system only for water quality treatment that collects project runoff and has no direct discharge capability other than percolation and evaporation. Off-line treatment systems provide storage of the treatment volume off-line from the primary conveyance path of flood discharges. A system utilizing detention with effluent filtration is not an off-line treatment system.

2.1.16 "On-line Treatment System"

A dual purpose system that collects project runoff for both water quality and water quantity requirements. Water quality volumes can be recovered through percolation, evaporation, filtration or detention.

2.1.17 "Open Drainage Basin"

Open drainage basins are all basins not meeting the definition of a closed drainage basin.

2.1.18 "Overflow Elevation"

The design elevation of a discharge structure at or below which water is contained behind the structure, except for that which leaks or bleeds out, through a control device down to the control elevation.

2.1.19 "Regulated Activity"

The construction, alteration, operation, maintenance, abandonment or removal of a system regulated pursuant to Part IV, Chapter 373, F.S., or Part V, Chapter 403, F.S.

2.1.20 "Surface Water or Stormwater Management System Facilities"

All components of a permitted surface water or stormwater management system including but not limited to all inlets, ditches, culverts, water control structures, retention and detention areas, ponds, lakes, floodplain compensation areas, wetlands and other surface waters and any associated buffer areas, and wetland mitigation areas.

2.1.21 "Water Management Areas"

Areas to be utilized for the conveyance or storage of surface water, mitigation, or perpetual operation and maintenance purposes.

History Note: SWFWMD ERP Information Manual Part B, Basis of Review, section 1.7 (definitions that are now contained in Volume I are not included); 2.1.21 transferred from Basis of Review section 2.6.2.2.5.

2.2 Professional Certification.

All construction plans, reports, specifications and supporting calculations submitted to the District for stormwater management systems that require the services of a registered professional must be signed, sealed, and dated by such registered professional. A "registered professional" is defined in Applicant's Handbook Volume I section 2.0(a)84.

History Note: Adapted from NFWWMD AH II section 2.3. Amended .

2.3 Tailwater Considerations.

"Tailwater" refers to the receiving water elevation (or pressure) at the final discharge point of the stormwater management system. Tailwater is an important component of the design and operation

of nearly all stormwater management systems and can affect any of the following management objectives of the system:

- (a) Peak discharge from the stormwater management system;
- (b) Peak stage in the stormwater management system;
- (c) Level of flood protection in the project;
- (d) Recovery of peak attenuation and stormwater treatment volumes; and
- (e) Control elevations, normal water elevation regulation schedules, and ground water management.

History Note: Adapted from NFWFMD AH II section 2.7.

2.3.1 Tailwater For Water Quality Design.

Stormwater management systems designed in accordance with the water quality design provisions in Part III of this Volume II must provide a gravity or pumped discharge that effectively operates (i.e., meets applicable rule criteria) under tailwater conditions. Acceptable criteria for demonstrating effective tailwater conditions include such criteria as mean annual high tide for tidal areas and mean annual wet-season high water elevation.

History Note: Adapted from NFWFMD AH II section 2.7.1.

2.3.2 Tailwater for Water Quantity Design.

Stormwater management systems designed in accordance with the water quantity provisions of Part IV of this Volume II must consider tailwater conditions. Receiving water stage can affect the amount of flow that will discharge from the project to the receiving water. Applicants are advised to use an appropriate time-stage relationship for a storm equal to the project design storm. Variable tailwater stages should be considered if they have a significant influence on the design.

History Note: adapted from NFWFMD AH II section 2.7.1; last sentence transferred from BOR 7.7.3

2.3.3 Regulated Systems.

Design and maintained stage elevations should be available either from the local jurisdiction or the District. Stages for frequencies other than the design will be estimated by the District upon request from the applicant.

History Note: SWFWMD ERP Information Manual Part B, Basis of Review, Section 7.7.1.

2.4 Retrofits of Existing Stormwater Water Management Systems.

a. A **stormwater retrofit project** is typically proposed by a county, municipality, state agency, or water management district to provide new or additional treatment or attenuation capacity, or improved flood control to an existing stormwater management system or systems. Stormwater retrofit projects shall not be proposed or implemented for the purpose of

providing the water quality treatment or flood control needed to serve new development or redevelopment. Example components of stormwater retrofit projects include:

1. Construction or alteration that will add additional treatment or attenuation capacity and capability to an existing stormwater management system;
2. Modification, reconstruction, or relocation of an existing stormwater management system or stormwater discharge facility;
3. Stabilization of eroding banks through measures such as adding attenuation capacity to reduce flow velocities, planting of sod or other vegetation, and installation of rip rap boulders ; or
4. Excavation or dredging of sediments or other pollutants that have accumulated as a result of stormwater runoff and stormwater discharges.

b. Stormwater Quality Retrofits.

1. The applicant for a stormwater quality retrofit project must provide reasonable assurance that the retrofit project itself will, at a minimum provide additional water quality treatment such that there is a net reduction of the stormwater pollutant loading into receiving waters. Examples are:

(a) Addition of treatment capacity to an existing stormwater management system such that it reduces stormwater pollutant loadings to receiving waters;

(b) Adding treatment or attenuation capability to an existing developed area when either the existing stormwater management system or the developed area has substandard stormwater treatment and attenuation capabilities, compared to what would be required for a new system requiring a permit under Part IV of Chapter 373, F.S.; or

(c) Removing pollutants generated by, or resulting from, previous stormwater discharges.

2. If the applicant has conducted, and the Agency has approved, an analysis that provides reasonable assurance that the proposed stormwater quality retrofit will provide the intended pollutant load reduction from the existing system or systems, the project will be presumed to comply with the water quality conditions for issuance discussed in Part IV of this Volume II.

3. The pollutants of concern will be determined on a case-by-case basis during the permit application review and will be based upon factors such as the type and intensity of land use, existing water quality data within the area subject to the retrofit, and the degree of impairment or water quality violations in the receiving waters.

c. Stormwater Quantity (Flood Control) Retrofits.

1. The applicant for a stormwater quantity retrofit project must provide reasonable assurance that the retrofit project will reduce existing flooding problems in such a way that it does not cause any of the following:

(a) A net reduction in water quality treatment provided by the existing stormwater management system or systems; or

(b) Increased discharges of untreated stormwater entering adjacent or receiving waters.

2. If the applicant has conducted, and the Agency has approved, an analysis that provides reasonable assurance that the stormwater quantity retrofit project will comply with the above, the project will be presumed to comply with the applicable water quantity conditions for issuance discussed in Part III of this Volume II.

d. The applicant for any stormwater retrofit project must design, implement, and operate the project so that it:

1. Will not cause or contribute to a water quality violation;

2. Does not reduce stormwater treatment capacity or increase discharges of untreated stormwater. Where existing ambient water quality does not meet water quality standards the applicant must demonstrate that the proposed activities will not cause or contribute to a water quality violation. If the proposed activities will contribute to the existing violation, measures shall be proposed that will provide a net improvement of the water quality in the receiving waters for those parameters that do not meet standards.

3. Does not cause any adverse water quality impacts in receiving waters; or

4. Will not cause or contribute to increased flooding of adjacent lands or cause new adverse water quantity impacts to receiving waters.

History Note: Derived from NFWFMD Applicant's Handbook Volume II, section 2.10

2.5 District Drainage Basins and Watersheds.

Pursuant to paragraph 62-330.302(1)(b), F.A.C., cumulative impacts upon wetlands and other surface waters are analyzed by evaluating impacts to water quality and functions provided by wetlands and other surface waters within the same drainage basin. A regulated activity shall not cause unacceptable cumulative impacts upon wetlands and other surface waters within the same drainage basin as the regulated activity for which a permit is sought. Further information on cumulative impact assessment appears in section 10.2.8 of Volume I. The District's adopted drainage basins for cumulative impact analysis and watersheds for mitigation bank purposes are the same and are set forth in Figure 2.5 which follows at the end of this chapter.

History Note: SWFWMD ERP Information Manual Part B, Basis of Review Appendix 6 and Appendix 4 Exhibit 1

2.6 Flexibility for State Transportation Projects and Facilities.

With regard to state linear transportation projects and facilities, the Agencies shall be governed by subsection 373.413(6), F.S. (2012).

History Note: New.

2.7 Inspections to Ensure Proper Operation and Maintenance

- (a) In accordance with subsection 62-330.311(1), F.A.C., stormwater management systems, dams, impoundments, reservoirs, appurtenant work, and works designed by a registered professional shall be inspected and documented by the registered professional as follows, unless otherwise specified in the permit. Permit conditions will specify the required inspection cycle, typically in accordance with the timelines outlined below:

TYPE OF SYSTEM	REINSPECTION SCHEDULE AFTER TRANSFER TO OPERATIONS PHASE
Retention	Once every 5 years
Wet Detention	Once every 5 Years
Detention with Effluent Filtration	Once every 2 Years
Underground Exfiltration	Once every 2 Years

- (b) Activities designed by a registered professional shall be inspected by that same registered professional, or by a similarly-registered professional in accordance with the inspection frequency and terms required in the permit.
- (c) Additional information on operation and maintenance requirements is contained in **Section 12.4 of Volume I** and in Rule 62-330.311, F.A.C.

History Note: New .

Figure 2.5

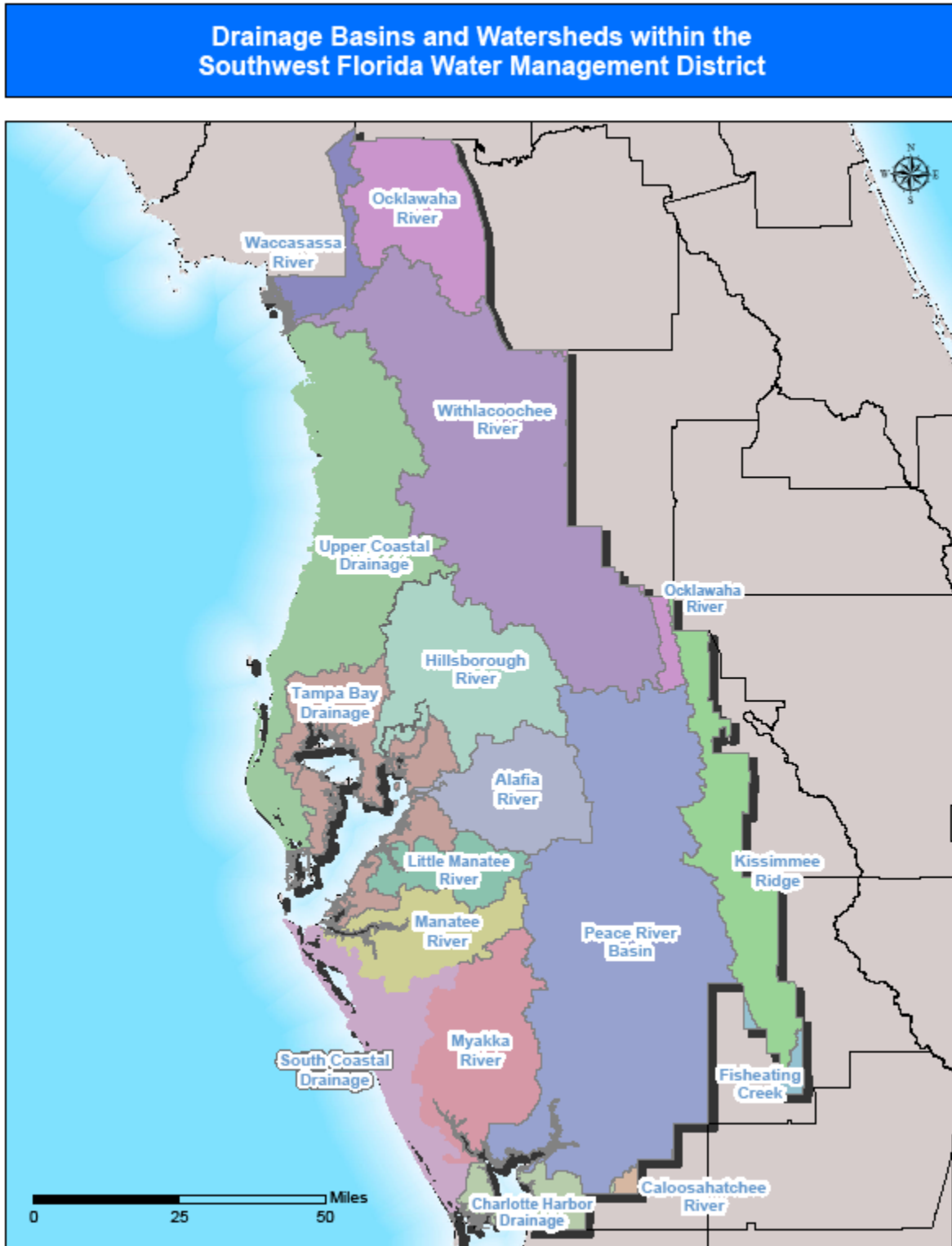

PART III -- STORMWATER QUANTITY/FLOOD CONTROL

3.0 General Stormwater Quantity and Flood Control Requirements.

Pursuant to the Conditions for Issuance in Section 62-330.301, F.A.C., an applicant must provide reasonable assurance that the proposed construction, alteration, operation, maintenance, removal or abandonment of the works or other activities regulated under ERP rules:

- a. Will not cause adverse water quantity impacts to receiving waters and adjacent lands;
- b. Will not cause adverse flooding to on-site or off-site property;
- c. Will not cause adverse impacts to existing surface water storage and conveyance capabilities; and
- d. Will not adversely impact the maintenance of surface or ground water levels or surface water flows established pursuant to Section 373.042, F.S., or Chapter 40D-8, F.A.C.

Utilization of the design criteria in this Part III will provide reasonable assurance of compliance with these conditions for issuance unless credible historical evidence of past flooding or the physical capacity of the downstream conveyance or receiving waters indicates that the conditions for issuance will not be met without consideration of storm events of different duration, frequency, or rainfall depth. In those instances, applicants shall be required to provide additional analyses using storm events of different duration, frequency, or rainfall depth than those referenced below, or to adjust the volume, rate or timing of discharges, to provide reasonable assurance of compliance with the conditions for issuance. Pre-application meetings are encouraged for projects in flood-prone areas to determine whether additional analysis is necessary to demonstrate reasonable assurance of compliance with the conditions for issuance.

History Note: SWFWMD ERP Information Manual Part B, Basis of Review, Section 4.1

3.1 Discharges.

Off-site discharge is limited to amounts which will not cause adverse off-site impacts.

a. For a project or portion of a project located within an open drainage basin, the allowable discharge is:

1. historic discharge, which is the peak rate at which runoff leaves a parcel of land by gravity under existing site conditions, or the legally allowable discharge at the time of permit application; or

2. amounts determined in previous District permit actions relevant to the project.

b. Except in situations as described in Section 3.0 above, off-site discharges and peak stages for the existing and developed conditions shall be computed using the Southwest Florida Water Management District's 24-hour, 25-year rainfall maps and the Natural Resources Conservation Service type II Florida Modified 24-hour rainfall distribution with an antecedent moisture condition II. See Appendix A for these items.

c. For a project or portion of a project discharging to a tidal water body, the peak discharge requirements of this section are not required, provided that the rate of discharge does not cause adverse impacts. Examples of tidal water bodies are the Gulf of Mexico and the Gulf Intracoastal Waterway, including manmade portions of the Gulf Intracoastal Waterway.

d. For a project or portion of a project located within a closed drainage basin, the required retention volume shall be the post-development runoff volume less the pre-development runoff volume computed using the Southwest Florida Water Management District's 24-hour/100-year rainfall map and the Natural Resources Conservation Service type II Florida Modified 24-hour rainfall distribution with an antecedent moisture condition II. The total post development volume leaving the site shall be no more than the total pre-development volume leaving the site for the design 100-year storm. The rate of runoff leaving the site shall not cause adverse off-site impacts. Maintenance of pre-development off-site low flow may be required in hydrologically sensitive areas.

e. Except in situations as described in 3.1.f below, the proposed stormwater management system shall not be required to account for storm events less frequent than the 25-year event for the rate of discharge in an open basin or the 100-year event for the volume of discharge in a closed basin.

f. For a project or portion of a project discharging to an open basin with limited downstream conveyance capacity (volume sensitive) or a basin that contains retention storage, then storage modeling or additional retention volume up to the 24-hour/100-year storm shall be provided such that the project stormwater discharge shall not cause adverse onsite or offsite impacts.

g. When not in conflict with the objectives of recharge, dewatering, or maintaining ground water levels, projects serviced by a permitted or approved regional surface water management system may discharge stormwater runoff at the rate and volume established by the agency operating the regional stormwater system. The permittee must provide written verification from the operating agency stating the acceptable rate and volume of stormwater runoff from the project.

History Note: SWFWMD ERP Information Manual Part B, Basis of Review, Section 4.2. (subsection c is added). Amended .

3.2 Flood Protection.

Flood protection for structures shall be provided as follows:

(a) Residential buildings shall have the lowest floor elevated above the 100-year flood elevation for that site.

(b) Industrial, commercial or other non-residential buildings susceptible to flood damage should have the lowest floor elevated above the 100-year flood elevation. Unless a higher elevation is required by applicable building code requirements, non-residential structures alternatively may be designed and constructed so that below the 100-year flood elevation the structure and attendant utility facilities are watertight and capable of resisting the effects of the regulatory flood. The design should take into account flood velocities, duration, rate of rise, hydrostatic and hydrodynamic forces, the effect of buoyancy and impacts from debris.

(c) Accessory buildings may be constructed below the 100-year flood elevation provided there is minimal potential for significant damage by flooding. An accessory building is a structure on the same parcel of property as a principal structure and the use of which is incidental to the use of the principal structure and not for human habitation. For example, a residential structure may have a detached garage, a carport, or storage shed for garden tools as accessory structures. Other examples of accessory structures include gazebos, picnic pavilions, boathouses, pole barns, storage sheds, and similar buildings. Applicants are cautioned that potential water quality impacts caused by flooding of contents housed in a structure will be considered in allowing a reduced finished floor elevation.

(d) Applicants are advised that local ordinances and the Florida Building Code may require higher minimum floor elevations.

History Note: SWFWMD ERP Information Manual Part B, Basis of Review, Section 4.3. Amended .

3.3 Flood Plain Encroachment.

No net encroachment into the flood plain, up to that encompassed by the 100-year event, which will adversely affect conveyance, storage, water quality or adjacent lands, will be allowed. Any required compensating storage shall be equivalently provided between the lowest level of encroachment and the 100-year flood level to allow storage function during all lesser flood events.

History Note: SWFWMD ERP Information Manual Part B, Basis of Review, Section 4.4. Amended .

3.4 100-Year Flood Level Determinations.

a. Flood elevations shall be determined using the most accurate information available, which can include:

1. Actual data, including water level, stream flow and rainfall records;
2. Hydrologic/hydraulic modeling;
3. Federal Flood Insurance Rate Maps and supporting flood study data; or
4. Floodplain analysis studies.

b. Site-specific data for observed and measured flood elevations shall be compared to modeled or existing study data to verify accuracy.

c. The 24-hour/100-year storm shall be used to determine the 100-year flood elevation except in those circumstances where credible historical evidence exists that higher flood stages have occurred, and can be expected to re-occur, following more frequent storm events. In those cases, the 100-year flood elevation shall be determined using a 100-year storm of sufficient duration to exceed the flood stages observed following more frequent events.

History Note: SWFWMD ERP Information Manual Part B, Basis of Review, Section 4.4.1. Amended .

3.5 Minimum Drainage.

Commercial and industrial projects to be subdivided for sale are required to install a minimum drainage system as described in (a) and (b) below. Projects permitted in such a manner shall require deed restrictions which notify lot or tract purchasers of the amount of additional on-site storm water management system necessary to provide flood attenuation and any additional retention/detention required for water quality purposes.

a. The required water quality system must have treatment capacity for one inch of runoff if wet detention is used, or one-half inch of runoff if retention, effluent filtration or exfiltration is used, from the total developed site and contributing offsite area.

b. A stormwater collection and conveyance system must be provided to interconnect the retention/detention system with the project outfall, including access points to the system available to each individual lot or tract. The system shall be sized to limit discharge under full build-out design conditions to the allowable discharge.

History Note: SWFWMD ERP Information Manual Part B, Basis of Review, Section 4.5.

3.6 Water Conservation, Low Flow and Base Flow Maintenance.

Where practicable, systems shall be designed to:

a. maintain water tables, base flows and low flows at the highest practicable level. The depth to which the water table can be lowered will be determined based on the potential adverse impact on recharge, the effect on water resources (quality and quantity), and the necessity for fill and its impact on existing natural upland vegetation; and

b. preserve site environmental values; and

c. not waste freshwater through overdrainage; and

d. not lower water tables which would adversely affect existing legal uses; and

e. preserve site groundwater recharge characteristics; and

f. retain water on-site for use and re-use for irrigation and other reasonable beneficial uses.

History Note: SWFWMD ERP Information Manual Part B, Basis of Review, section 4.6.

3.6.1 Minimum Flows and Levels.

In addition to the design considerations in Section 3.6 above, the system shall not reduce or suppress the flow of a watercourse or the level of water in a wetland or other surface water or the level of ground water below a minimum flow or level that has been established pursuant to Section 373.042, F.S.

History Note: SWFWMD ERP Information Manual Part B, Basis of Review, Section 4.6.1.

3.6.2 Water Withdrawals.

The effects of water withdrawals shall not be considered as the ambient condition in the design of stormwater management systems permitted under Chapter 62-330, F.A.C., except to the extent that the long term success of mitigation would be adversely affected by such water withdrawals.

History Note: SWFWMD ERP Information Manual Part B, Basis of Review Section 4.6.2.

3.7 Historic Basin Storage.

Provision must be made to replace or otherwise mitigate the loss of historic basin storage provided by the project site.

History Note: SWFWMD ERP Information Manual Part B, Basis of Review, Section 4.7.

3.8 Offsite Lands.

The application shall include provisions to allow drainage from off-site upgradient areas to downgradient areas without adversely altering the time, stage, volume, point or manner of discharge or dispersion and without degrading water quality.

History Note: SWFWMD ERP Information Manual Part B, Basis of Review, Section 4.8.

3.9 Isolated Wetlands.

Isolated wetlands wholly owned or controlled by the applicant may be used for flood attenuation purposes when not in conflict with environmental or public use considerations.

History Note: SWFWMD ERP Information Manual Part B, Basis of Review, Section 4.9.

3.10 Rural or Minor Subdivisions.

Rural or minor residential subdivisions constructed and operated in accordance with the design and construction criteria specified in Section 5.10 will be presumed to provide reasonable assurance of compliance with the water quantity-related conditions for issuance described in Part III of this Volume II.

History Note: Adapted from 40D-40.301, F.A.C. (9/5/2010). Amended .

PART IV -- STORMWATER QUALITY

4.0 Purpose.

Projects shall be designed so that discharges will meet applicable state water quality standards. Projects designed using the criteria found in this section shall be presumed to provide reasonable assurance of compliance with the state water quality standards referenced in Section 62-330.301(1)(e), F.A.C. The applicant may also provide reasonable assurance of compliance with state water quality standards by the use of alternative methods that will provide treatment equivalent to systems designed using the criteria specified in this section. If the applicant chooses to use alternative methods the District will determine whether the applicant has provided reasonable assurance based on information specific to the proposed design and submitted by the applicant.

History Note: SWFWMD ERP Information Manual Part B, Basis of Review, Section 5.1.

4.1 Retention and Detention Criteria.

The volume of runoff to be treated from a site shall be determined by the type of treatment system, i.e., wet detention, detention with effluent filtration, on-line retention treatment system, or off-line retention treatment system. If off-site run-off is not prevented from combining with on-site runoff prior to treatment, then treatment must be provided for the combined off-site/project runoff.

a. Wet Detention Systems.

1. A wet detention treatment system shall treat one inch of runoff from the contributing area.

2. A manmade wet detention system shall include a minimum of 35 percent littoral zone, concentrated at the outfall, for biological assimilation of pollutants. The percentage of littoral zone is based on the ratio of vegetated littoral zone to the surface area of the pond at the control elevation. The littoral zone shall be no deeper than 3.5 feet below the design overflow elevation. The treatment volume should not cause the pond level to rise more than 18 inches above the control elevation. Mulching and/or planting is desirable but not required, unless the soils in the proposed littoral zone are not capable of supporting wetland vegetation. In this case mulching will be required. Native vegetation that becomes established in the littoral zone must be maintained as part of the operation permit.

3. Isolated natural wetlands can be used as a wet detention system when not in conflict with environmental or public use considerations.

(a) If the required treatment volume cannot be detained within the limits of the isolated wetland boundaries and range of natural water levels, expansion of the wetland will be allowed when it can be shown that the excavation will not adversely impact the wetland.

(b) The treatment volume cannot adversely impact the wetland so that it fluctuates beyond the range of natural water levels. The available volume is determined based on site-specific conditions and an analysis of the isolated wetland to be used.

(c) Provisions must be made to remove sediment, oils and greases from runoff entering the wetland. This can be accomplished through incorporation of sediment sumps, baffles and dry grassed swales or a combination thereof. Normally, a dry grassed swale system designed for detention of the first one-fourth inch of runoff with an overall depth of no more than 4 inches will satisfy the requirement for prior removal of sediment, oils and greases.

4. The wet detention system's treatment volume shall be discharged in no less than 120 hours (5 days) with no more than one-half the total volume being discharged within the first 60 hours (2.5 days).

5. Due to the detention time required for wet detention systems, only that volume which drains below the overflow elevation within 36 hours may be counted as part of the volume required for water quantity storage under Part III of this Volume II.

6. Concepts and methods for determining design pool requirements for an alternative wet detention designs system through Conservation Wet Detention designs can be found in Appendix B.

History Note: SWFWMD ERP Information Manual Part B, Basis of Review, Section 5.2.a.1-5. Amended .

b. Detention with Effluent Filtration System (Manmade Underdrains).

1. A detention with effluent filtration system shall treat the runoff from the first one inch of rainfall; or as an option for projects or project subunits with drainage areas less than 100 acres, the first one-half inch of runoff. In determining the runoff from one inch of rainfall, the applicant must provide calculations determining runoff from the directly connected impervious and semi-impervious areas separately from any other contributing area.

2. Filtration systems shall have a minimum of 0.5 feet of vertical head between the center line of the perforated pipe and the normal water elevation or the pond bottom of the system. The seasonal high water level must be at least one foot below the center line of the perforated pipe (measured from the lowest point of the perforated pipe), or separated by structural means from the hydraulic contribution of the surrounding water table. The stormwater must pass through a minimum of two feet of the filter material before entering the perforated pipe.

3. Filtration systems shall have pore spaces large enough to provide sufficient flow capacity so that the permeability of the filter is equal to or greater than the surrounding soil. The design shall ensure that the filter medium particles do not move. The filter material shall be of a quality sufficient to satisfy the requirements listed below, but these requirements are not intended to preclude the use of multilayered filters nor the use of materials to increase ion exchange, precipitation or pollutant absorption capacity of the filter. The requirements are:

(a) Washed material meeting FDOT road and bridge specifications for silica sand and quart gravels, or mixtures thereof (less than 1 percent silt, clay and organic matter), unless filter cloth is used which is suitable to retain the silt, clay and organic matter within the filter; calcium carbonate aggregate is not an acceptable substitute;

(b) Uniformity coefficient 1.5 or greater; and

(c) Effective grain size of 0.20 to 0.55 millimeters in diameter.

4. The total detention volume shall again be available within 36 hours.
5. The treatment volume can be counted as part of the storage required for water quantity storage under Part III of this Volume II.
6. Maintenance of filter includes proper disposal of spent filter material.
7. The design of the system must be such that the water velocities and associated flow path through the storage pond do not cause the accumulated pollutants to be flushed out of the treatment pond up to the 25-year, 24-hour design storm.

History Note: SWFWMD ERP Information Manual Part B, Basis of Review, Section 5.2.b. Amended .

c. On-line Retention Treatment Systems.

1. An on-line retention treatment system shall treat the runoff from the first one-inch of rainfall; or as an option for projects or project sub-units with drainage areas less than 100 acres, the first one-half inch of run-off. In determining the runoff from one-inch of rainfall, the applicant must provide calculations determining runoff from the directly connected impervious and semi-impervious areas separately from any other contributing area.

2. Total treatment volume shall again be available within 72 hours, however, only that volume which can again be available within 36 hours may be counted as part of the volume required for water quantity storage under Part III of this Volume II.

3. The design of the system must be such that the water velocities and associated flow path through the storage pond do not cause the accumulated pollutants to be flushed out of the treatment pond up to the 25-year, 24-hour design storm.

History Note: SWFWMD ERP Information Manual -Part B, Basis of Review, Section 5.2.c. Amended .

d. Off-line Retention Treatment Systems.

1. Off-line retention treatment systems shall treat the runoff from the first one-inch of rainfall; or as an option for projects or project sub-units with drainage areas less than 100 acres, the first one-half inch of runoff. In determining the runoff from one-inch of rainfall, the applicant must provide calculations determining run-off from the directly connected impervious and semi-impervious areas separately from any other contributing area.

2. Total treatment volume shall again be available within 72 hours, however, only that volume which can again be available within 36 hours may be counted as part of the volume required for water quantity storage under Part III of this Volume II.

History Note: SWFWMD ERP Information Manual Part B, Basis of Review, Section 5.2.d. Amended .

e. Underground Exfiltration Treatment Systems.

1. Systems shall be designed for the volumes specified in Section 4.1(d) for off-line treatment systems.
2. Systems must have the capacity to retain the required retention volume without considering discharges.
3. The seasonal high water level must be at least one foot below the bottom of the exfiltration pipe.
4. Systems should not be proposed for projects to be operated by entities other than single owners or entities with full time maintenance staffs.
5. A safety factor of 2.0 or more shall be applied to the exfiltration design to allow for geological uncertainties by dividing the exfiltration rate by the safety factor.
6. Total system required volume shall again be available within 72 hours.
7. Due to the maintenance requirements and life expectancy of exfiltration systems, the treatment volume required in Section 4.1(d) cannot be counted as part of the storage volumes required under Section 3.1 of Volume II.
8. Exfiltration systems shall comply with the following construction requirements:
 - (a) Pipe diameter must be a minimum of 12 inches;
 - (b) Trench width must be a minimum of 3 feet;
 - (c) Rock material in trenches must be enclosed in filter material; and
 - (d) Maintenance sumps must be provided in inlets.

History Note: SWFWMD ERP Information Manual Part B, Basis of Review, Sections 5.7 and 6.5. Amended

f. Discharges to Outstanding Florida Waters.

Projects discharging directly into Outstanding Florida Waters (OFW) shall be required to provide treatment for a volume 50 percent more than required for the selected treatment system (wet detention, detention with effluent filtration, on-line retention or off-line retention).

History Note: SWFWMD ERP Information Manual Part B, Basis of Review, Section 5.2.e.

g. Where Ambient Water Quality Does Not Meet Standards.

In instances where an applicant is unable to meet water quality standards because existing ambient water quality does not meet standards and the system will contribute to this existing condition, mitigation for water quality impacts can consist of water quality enhancement. In these cases, the applicant must implement mitigation measures that are proposed by or acceptable to the applicant

that will cause net improvement of the water quality in the receiving waters for those contributed parameters that do not meet standards.

History Note: SWFWMD ERP Information Manual Part B, Basis of Review, Section 3.2.4.5.

h. Off-site Treatment Volumes.

Off-site treatment volumes shall be the total runoff from one-inch of rainfall over the contributing off-site area. The runoff from the directly connected impervious and semi-impervious contributing areas shall be determined separately from the runoff from the other contributing areas.

History Note: SWFWMD ERP Information Manual Part B, Basis of Review, Section 5.2.f.

4.2 Public Supply Wells.

Stormwater retention and detention systems are classified as moderate sanitary hazards with respect to public and private drinking water wells. Stormwater treatment facilities shall not be constructed within 100 feet of an existing public water supply well and shall not be constructed within 75 feet of an existing private drinking water well.

History Note: SWFWMD ERP Information Manual Part B, Basis of Review, Section 5.3 and NFWWMD Applicant's Handbook Volume II, Section 4.3.2. Amended

4.3 Sewage Treatment Percolation Ponds.

Above ground pond dikes shall not be located within 200 feet of water bodies or 100 feet of dry retention areas. The applicant may propose specific alternative measures that are equivalent to these criteria in their effectiveness to protect the water resources and adjacent property. The applicant shall provide the District with reasonable assurance of no adverse impact to the water resources or adjacent property, based on the plans, calculations and other information specific to the design proposed.

History Note: SWFWMD ERP Information Manual Part B, Basis of Review, Section 5.4.

4.4 Solid Waste Facilities.

Surface water management systems for Class I and II solid waste facilities, as defined in Chapter 62-7, F.A.C., shall be designed and constructed to maintain the integrity of the landfill at all times including construction, operation, closure and post closure. Applicants should consult with District staff prior to submittal of an application to determine the specific requirements which will apply for a particular project.

History Note: SWFWMD ERP Information Manual Part B, Basis of Review, Section 5.5.

4.5 Alterations to Existing Public Roadway Projects.

Alterations to existing public roadway projects will be required to treat a volume equal to those specified in Section 4.1 and the contributing area according to the following options:

a. The contributing area(s) to be used in calculating the required treatment volume will be:

1. For off-line treatment systems and on-line treatment systems, including wet-detention, which provide storage of the treatment volume off-line from the primary conveyance path of flood discharges, use the area of new pavement.

2. For all other on-line treatment systems, including wet-detention, use the entire on-site directly connected impervious areas contributing to the system; directly connected impervious areas are those new and existing pavement areas connected to the treatment systems by pavement or pipe that contribute untreated runoff.

b. When alterations involve extreme hardship, in order to provide direct treatment of new project area, the District will consider proposals to satisfy the overall public interest that shall include equivalent treatment of alternate existing pavement areas to achieve the required pollution abatement. For example, existing untreated contributing areas not otherwise required to be included for treatment may be included for treatment by the system in lieu of direct treatment of new project area when the pollution abatement is equivalent and benefits the same receiving waters.

c. Existing treatment capacity being displaced by any roadway project will require additional compensating treatment volume. Additional volume is also required for projects that discharge directly to OFW's. (See Section 4.1.f.)

Subsection 373.413(6), F.S. (2012), also requires that Agencies exercise flexibility in the permitting of stormwater management systems associated with the construction or alteration of systems serving state transportation projects and facilities.

History Note: SWFWMD ERP Information Manual Part B Basis of Review, Section 5.8.

4.6 Water Quality Monitoring.

All non-exempt surface water management systems will be evaluated based on the ability of the system to prevent degradation of receiving waters and its ability to conform to state water quality standards.

History Note: SWFWMD ERP Information Manual Part B Basis of Review, Section 5.9.

4.7 General and Special Conditions Related To Water Quality Monitoring By Permittees.

a. If the applicant utilizes design criteria found in Part IV of Volume II, monitoring will not be required.

b. Monitoring shall be required when the applicant proposes design criteria not found in Part IV of Volume II, and does not have specific test data or other data to support that state water quality standards will be met.

c. Monitoring may be required in cases where there may be a real and immediate concern regarding degradation of quality in the receiving waters, regardless of the pollutant removal efficiency of the drainage system.

d. The reason for the monitoring requirement will be stated in each permit for which water quality monitoring is required, along with the monitoring schedule and the parameters of interest. Samples will be collected at discharge locations unless other locations are identified in the monitoring schedule. Monitoring schedules will require the periodic collection of samples. Permittees will also be required to collect samples during storm events, provide the rate of discharge and total discharge quantities at the time of sample collection, if necessary to ensure that state water quality standards will be met.

e. Permits for projects not requiring water quality monitoring at the time of permit issuance will include a statement that water quality monitoring will be required in the future if necessary to ensure that state water quality standards are being met. This should not be construed as an indication that the District is contemplating the implementation of a program of intensive water quality monitoring by all permittees.

History Note: SWFWMD ERP Information Manual Part B Basis of Review, Sections 5.10, 5.11 and 5.13. Amended

4.8 Compensating Stormwater Treatment.

Occasionally, applicants find that it is impractical to construct a stormwater management system to capture the runoff from a portion of the project site due to on-site conditions such as extreme physical limitations, availability of right-of-way, or maintenance access. Two methods have been developed to compensate for the lack of treatment for a portion of a project. The first method is to treat the runoff that is captured to a greater extent than required by rule (i.e., "overtreatment"). The second method is to provide treatment for an off-site area which currently is not being treated (i.e., "off-site compensation"). Each method is designed to furnish the same level of treatment as if the runoff from the entire project site were captured and treated in accordance with the provisions of this Volume.

Either of these methods will only be allowed as a last resort and the applicant is strongly encouraged to schedule a pre-application conference with District staff to discuss the project if these alternatives are being considered. Other rule criteria, such as peak discharge attenuation, will still have to be met if the applicant utilizes these methods. Each alternative is described in more detail in the following sections.

History Note: NFWFMD AH II section 2.11.

4.8.1 Overtreatment.

Overtreatment means to treat the runoff from the project area that does flow to a treatment system to a higher level than the rule requires, to make up for the lack of treatment for a portion of the project. The average treatment efficiency of the areas treated and the areas not treated must meet the pollutant removal goals of Chapter 62-40, F.A.C., (i.e., 80% removal for discharges to Class III waters and 95% removal for systems which discharge to OFWs). To meet these goals, the area not being treated generally must be small (less than 10%) in relation to the area which is captured and treated. Staff can aid in determining the proper level of overtreatment for a particular situation.

History Note: NFWFMD AH II Section 2.11.1.

4.8.2 Off-site Compensation.

Off-site compensation means to provide treatment to compensate for the lack of treatment for portions of the proposed project. The following conditions must be met when utilizing off-site compensation:

(a) The off-site area must be in the same watershed and benefit the same receiving water body as the proposed project, and should be in the closest vicinity practicable to the location of those untreated stormwater discharge(s) requiring compensating treatment; and

(b) The applicant shall use modeling or other data analysis techniques that provide reasonable assurance that the compensating treatment system removes at least the same amount of stormwater pollution loading as was estimated from the untreated project area.

History Note: NWFWMMD AH II Section 2.11.2.

4.9 Rural or Minor Subdivisions.

Rural or minor residential subdivisions constructed and operated in accordance with the design and construction criteria specified in Section 5.10 will be presumed to provide reasonable assurance of compliance with the water quality-related conditions for issuance described in Part IV of Volume II.

History Note: Adapted from 40D-40.301, F.A.C.

PART V –CONSTRUCTION DESIGN REQUIREMENTS

5.0 Design Criteria.

The design criteria and construction requirements applicable within this District for stormwater management system discharge or control structures, retention and detention areas and other system features are set forth in Part V of Volume II. To assist the applicant, additional reference materials and figures useful in designing stormwater management systems appear in the Appendices and should be consulted.

History Note: New 10-1-13. Amended .

5.1 Discharge Structures.

a. The construction design for all surface water systems shall be adequate to meet all design criteria and performance standards referred to in this rule. Provision shall be made for the controlled release of water volumes in excess of that caused by the design storm event to ensure adequate performance of the system and its continued safe operation. Construction designs shall include adequate provisions to allow operation and maintenance activities and to prevent unauthorized operation of operable structures.

b. All design discharges shall be made through structural discharge facilities. Discharge structures shall be fixed so that discharge cannot be made below the control elevation, except that emergency operation devices may be designed and installed with secure locking mechanisms.

c. Non-operable discharge structures shall not be constructed so that they are operable.

d. Discharge structures shall include gratings for safety and maintenance purposes. The use of trash collection screens is desirable.

e. Discharge structures for water quality systems shall include a "baffle" system to encourage discharge from the center of the water column rather than the top or bottom. Discharge structures from areas with greater than 50 percent impervious and semi-impervious area or from systems with inlets in paved areas shall include a baffle, skimmer, or other mechanism suitable for preventing oil and grease from discharging from detention and on-line treatment systems.

f. Direct discharges, such as through culverts, stormdrains, weir structures, etc., will be allowed to receiving waters which by virtue of their large capacity, configuration, etc. are easily able to absorb concentrated discharges. Examples of such receiving waters include existing storm sewer systems and man-made ditches, canals and lakes.

g. Indirect discharges, such as overflow and spreader swales, are required where the receiving water or its adjacent supporting ecosystem might be degraded by a direct discharge. The discharge structure must discharge into the overflow, spreader swale, etc. which in turn releases the water to the actual receiving water. Affected receiving waters include natural streams, lakes, marshes, isolated wetlands and land naturally receiving overland sheet flow.

h. Pumped systems will only be allowed for single owner or governmental agency operation entities, unless perpetual operation ability can be guaranteed.

History Note: SWFWMD ERP Information Manual Part B, Basis of Review, Section 6.1.

5.2 Control Devices/Bleed-Down Mechanisms for Detention Systems.

a. When not in conflict with meeting the District's pre-/post-peak discharge requirement or a more restrictive local government discharge requirement, gravity control devices normally shall be designed to discharge one-half of the detention volume required by Part III of Volume II, within 24 hours. Devices incorporating dimensions smaller than six square inches of cross sectional area or two inches minimum dimension or less than 20 degrees for "V" notches shall include a device to eliminate clogging. Such devices include baffles, grates, pipe elbows, etc.

b. Gravity control devices for wet detention water treatment systems as specified in Part IV of Volume II are required to be designed to meet the bleed-down times specified therein. Devices incorporating dimensions smaller than those indicated in a. above, must include a device to eliminate clogging. Such devices include baffles, grates, pipe elbows, etc.

c. Wet detention systems designed for both water treatment (quality) and attenuation of the design storm (quantity) must incorporate the requirements of a. and b. above.

History Note: SWFWMD ERP Information Manual Part B, Basis of Review, Section 6.2. Amended

5.3 Maintenance Considerations. The design of retention areas shall incorporate consideration of sediment removal, regular maintenance and vegetation harvesting procedures.

History Note: SWFWMD ERP Information Manual Part B, Basis of Review, Section 6.3.

5.4 Retention and Detention Areas.

5.4.1 Dimensional Criteria (as measured at or from the control elevation).

a. Width - Wet detention water quality treatment systems shall be designed with a 100 foot minimum width for linear areas in excess of 200 feet in length. Area and width requirements will be waived for projects to be operated by single owner entities, or entities with full time maintenance staffs with a particular interest in maintaining the area, e.g., golf courses. Treatment areas not meeting the above width to length ratio will be approved if the permittee can demonstrate that the design of the system will maximize circulation by location of inflow and outflow points.

b. Depth - The detention or retention area shall not be excavated to a depth that breaches an aquitard such that it would allow for lesser quality water to pass, either way, between the two systems. In those geographical areas of the District where there is not an aquitard present, the depth of the pond shall not be excavated to within two (2) feet of the underlying limestone which is part of a drinking water aquifer.

c. Side slopes – for purposes of public safety, water quality treatment and maintenance, all retention or detention areas should have stabilized side slopes no steeper than 4:1 (horizontal: vertical) out to a depth of two feet below the control elevation. Except as provided for in paragraph 5.4.1(d), constructed side slopes steeper than 3.5:1 (horizontal: vertical) shall be considered a substantial deviation from the permitted design.

d. For purposes of public safety, side slopes designed or permitted steeper than 4:1 will require a six foot chain link fence or other protection sufficient to prevent accidental incursion into the retention or detention area. In determining the sufficiency of other protection measures, consideration shall be given to the depth and morphometry of the detention or retention area, surrounding land uses, degree of public access, and likelihood of accidental incursion.

e. For wet detention systems, the bottom elevation of the pond must be at least one foot below the control elevation.

History Note: SWFWMD ERP Information Manual Part B, Basis of Review, Section 6.4.1 for subsections a – d; Section 1.7.4 for subsection e. Amended

5.4.2 Maintenance Access.

Perimeter maintenance and operation easements, with a minimum width of 20 feet and slopes no steeper than 4:1 (horizontal: vertical), should be provided landward of the control elevation water line. Widths less than 20 feet are allowed when it can be demonstrated that equipment can enter and perform the necessary maintenance for the system.

History Note: SWFWMD ERP Information Manual Part B, Basis of Review, Section 6.4.2.

5.5 Exfiltration Systems Dimensional Criteria.

Exfiltration systems shall comply with the following construction requirements:

- a. Pipe diameter must be a minimum of 12 inches;
- b. Trench width must be a minimum of 3 feet;
- c. Rock material in trenches must be enclosed in filter material; and
- d. Maintenance sumps must be provided in inlets.

History Note: SWFWMD ERP Information Manual Part B, Basis of Review, Section 6.5.

5.6 Management of Runoff from Impervious and Semi-Impervious Areas.

Runoff shall be discharged from impervious and semi-impervious surfaces into retention areas, or through detention devices, filtering and cleansing devices, or subjected to some type of Best Management Practice (BMP) prior to discharge from the project site. For projects, which include substantial paved areas, such as shopping centers, large highway intersections with frequent stopped traffic, and high density developments, provisions shall be made for the removal of oil, grease and sediment from storm water discharges.

History Note: SWFWMD ERP Information Manual Part B, Basis of Review, Section 6.6.

5.7 Stagnant Water Conditions.

Configurations which create stagnant water conditions, such as dead end canals, are prohibited, regardless of the type of development.

History Note: SWFWMD ERP Information Manual Part B, Basis of Review, Section 6.7.

5.8 Sediment Sumps.

Sediment sumps shall comply with the following:

- a. Sumps shall remove a particle size of 0.1 mm in diameter (approximately a No. 100 sieve size) unless it can be shown another grain size is more appropriate for the site.
- b. Sumps shall be designed for an inflow rate equal to the design peak flow rate of the project's internal storm water system.
- c. A maintenance schedule for sediment and vegetation removal must be included.

History Note: SWFWMD ERP Information Manual Part B, Basis of Review, Section 6.8.

5.9 Dam Safety.

All dams must be designed, constructed, operated and maintained consistent with accepted engineering and dam safety practices as applied to local conditions, considering such factors as type of materials, type of soils and degree of compaction, hydrologic capacity, construction techniques and hazard rating. A document that provides useful information for this purpose is *Design of Small Dams*, U.S. Department of the Interior, Bureau of Reclamation, Third Edition, 2006.

History Note: Adapted from NFWMD AHI Section 8.4.7.

5.10 Rural or Minor Residential Subdivisions.

a. Rural or minor residential subdivisions typically are designed to have large multi-acre lots and minimal roadways that, together, result in a relatively small amount of additional impervious or semi-impervious surfaces compared to pre-developed conditions. Rural or minor residential subdivisions that are designed in accordance with the following parameters will be considered to not cause significant adverse impacts to occur individually or cumulatively and will meet the applicable water quality and water quantity design criteria for permit issuance:

(1) The proposed activities will occur in, on or over less than 100 square feet of wetlands or other surface waters. Road or driveway crossings of ditches constructed in uplands will not be counted against the 100 square foot limit.

(2) The activities will not utilize pumps for storm water management.

(3) The activities will not utilize storm drainage facilities larger than one 24-inch diameter pipe, or its equivalent.

(4) Discharges from the site will meet state water quality standards.

(5) The proposed building floors will be above the 100 year flood elevation.

(6) The surface water management system can be effectively operated and maintained.

(7) Roadways within the subdivision will consist of paved or unpaved stabilized roads with an unyielding subgrade.

(8) The drainage system will not act in a manner that would divert and channelize large areas of overland sheet flow, thereby creating point source discharges that will adversely affect wetlands, or areas beyond the applicant's perpetual control.

(9) Point discharges will not exceed the capacity of receiving waters.

(10) All terminal discharge structures are designed to withstand the 25-year, 24-hour post-development discharge without functional failure.

(11) The proposed post-development impervious and semi-impervious surfaces will not exceed a five percent (5%) increase over pre-developed conditions.

(12) Proposed or projected construction will maintain a minimum 75 foot vegetated buffer, which includes a 25 foot perpetually undisturbed buffer upland of all wetlands and other surface waters. Only the 25 foot perpetually undisturbed buffer will be required adjacent to an isolated wetland entirely located within an individual residential lot.

(13) Proposed or projected construction will maintain a minimum 75 foot buffer adjacent to all project boundaries.

b. The applicant's demonstration of compliance with this subsection shall include provision of a typical lot layout showing proposed driveways, buildings, and other impervious and semi-impervious areas and the anticipated percentage of impervious and semi-impervious surfaces resulting from projected construction on individual residential lots.

c. The boundaries of the surface water management system, wetlands, surface waters and buffers shall be recorded in plats or easements and included in any declaration of covenants, conditions, easements and restrictions and shall be identified in all sales contracts by the developer. These recorded documents shall be perpetual and applicable to all future sales of property within the development. Language shall also be contained in the recorded documents notifying all individual lot owners that permits are required if any of the following items are proposed:

(1) Alteration to the surface water management system; or

(2) Encroachment into the wetlands, wetland buffers, or adjacent off-site property line buffers.

History note: Transferred from 40D-40.301(1) and (2), F.A.C.

5.11 Sensitive Karst Areas.

"Karst" is a geologic term used to describe areas where landscapes have been affected by the dissolution of limestone or dolostone, including areas where the formation of sinkholes is relatively common. In parts of the District, limestone (or dolostone) that makes up or comprises the Floridan Aquifer System occurs at or near the land surface. Sediments overlying the limestone can be highly permeable. Due to its chemical composition, limestone is susceptible to dissolution when

it interacts with slightly acidic water. “Sensitive karst areas” reflect areas with hydrogeologic and geologic characteristics relatively more conducive to potential contamination of the Floridan Aquifer System from surface pollutant sources. The formation of karst-related features, such as sinkholes, is also more likely to occur in these areas.

Especially in sensitive karst areas, stormwater management systems must be designed and constructed to prevent direct discharge of untreated stormwater into the Floridan Aquifer System. Systems also must be designed and constructed in a manner that avoids breaching an aquitard and such that construction excavation will not allow direct mixing of untreated water between surface waters and the Floridan Aquifer System. The system shall also be designed to prevent the formation of solution pipes or other types of karst features in any known sensitive karst area. Test borings located within the footprint of a proposed stormwater management pond must be plugged in a manner to prevent mixing of surface and ground waters.

As provided in paragraph 5.4.1(b) of this Volume II, in areas where karst conditions are present, the detention or retention area shall not be excavated to a depth that breaches an aquitard such that it would allow for lesser quality water to pass, either way, between the two systems.

Figures depicting conditions that may occur when retention or detention ponds are constructed in sensitive karst areas appear in Appendix C.

History Note: Adapted from NFWMD AH II sections 17.1 and 17.3; SWFWMD ERP Information Manual Part B, Basis of Review, Section 6.4.1.b. Amended

PART VI – DESIGN INFORMATION

6.0 Design Criteria.

The design criteria set forth in this section are applicable within this District.

History Note: New

6.1 Antecedent Conditions.

Within this District, the antecedent condition will be the normal average wet season (AMC II).

History Note: SWFWMD ERP Information Manual Part B, Basis of Review, Section 7.1.

6.2 Rainfall Volume.

The rainfall isohyetal maps in APPENDIX A of this Volume II will be used to determine rainfall amounts.

History Note: SWFWMD ERP Information Manual Part B, Basis of Review, Section 7.2; Part D Project Design Aids.

6.3 Rainfall Distribution.

The Natural Resource Conservation Service Type II Florida Modified rainfall distribution will be used unless the applicant demonstrates that a different distribution better characterizes the actual rainfall distribution based on rainfall record.

History Note: SWFWMD ERP Information Manual Part B, Basis of Review, Section 7.3.

6.4 Open Surface Storage.

If open surface storage is to be considered in the review, the applicant must submit stage-storage computations. If open surface storage plus discharge is to be considered, the stage discharge computations will also be submitted. Actual rather than allowable discharges shall be used in routing. Discharges will be based on the tailwater resulting from the normal seasonal high water elevation of the receiving waters. For extreme events, such as the 100-year frequency, discharge will be based on the tailwater resulting from a 100-year flood on the receiving waters.

History Note: SWFWMD ERP Information Manual Part B, Basis of Review, Section 7.4.1.

6.5 Ground Surface Infiltration.

Ground surface infiltration will be reviewed on the basis of commonly accepted procedures. Suggested commonly accepted procedures include: the U.S. Department of Agriculture, Soil Conservation Service Technical Paper No. 149, "A Method for Estimating Volume and rate of Runoff in Small Watersheds" (1973); the U.S. Department of Agriculture, Soil Conservation Service Technical Release No. 55, "Urban Hydrology for Small Watersheds" (1975); or the Rational Method as discussed in the State of Florida Department of Transportation, "Drainage Manual" (January 2013) or Hydrology Handbook (February 2012) or standard civil engineering

textbooks. Site-specific test data should be submitted to support other methods of calculating ground surface infiltration.

Additional, more current references and design aids are listed in Appendix D.

History Note: SWFWMD ERP Information Manual Part B, Basis of Review, Section 7.5.1, with updated references.

6.6 Subsurface Exfiltration.

Subsurface exfiltration will be reviewed only on the basis of representative or actual test data submitted by the applicant. Tests shall be consistent as to elevation, location, soils, etc., with the system design to which the test data will be applied.

History Note: SWFWMD ERP Information Manual Part B, Basis of Review, Section 7.5.2.

6.7 Runoff.

The usual methods of computation of runoff used by project designers and acceptable to the District are as follows:

- a. Rainfall minus losses and storage.
- b. Soil Conservation Service design methods (see, for example, U.S. Department of Agriculture, Soil Conservation Service, "National Engineering Handbook, Section 4, Hydrology." Additional, more current reference sources and design aids can be found in Appendix D.)
- c. Rational method, for systems serving projects of less than 10 acres total contributing area. Suggested references and design aids are listed in Appendix D.
- d. Other alternative methods and criteria proposed by the applicant that are functionally equivalent to the criteria in District rules. The applicant shall provide the District with reasonable assurance of such equivalency based on the submitted plans, calculations and other information.

History Note: SWFWMD ERP Information Manual Part B, Basis of Review, Section 7.6.

6.8 Allowable Discharges.

Peak discharge, for purposes of meeting maximum allowable discharges, is computed as the maximum average discharge over a time period equal to the time of concentration of the contributory area.

History Note: SWFWMD ERP Information Manual Part B, Basis of Review, Section 7.8.1

APPENDICES

- APPENDIX A - Part D of SWFWMD ERP Information Manual Rainfall Maps (July 1996)
- APPENDIX B - Conservation Wet Detention Alternative Treatment Design Technical Memorandum Concepts and Methods
- APPENDIX C - Figures Relating to Water Quality Provisions, Water Quantity Provisions and Retention Systems Within Sensitive Karst Areas
- APPENDIX D - Operating Agreement Concerning Regulation Under Part IV, Chapter 373, F.S., Between Southwest Florida Water Management District and Department of Environmental Protection (July 1, 2007)
- APPENDIX E - Flexibility for State Transportation Projects and Facilities

APPENDIX A

ENVIRONMENTAL RESOURCE PERMITTING

INFORMATION MANUAL

PART D

Project Design Aids

July 1996

Pages D-1 through D-12

Southwest Florida Water Management District

PART D
PROJECT DESIGN AIDS

ENVIRONMENTAL RESOURCE PERMITTING
INFORMATION MANUAL

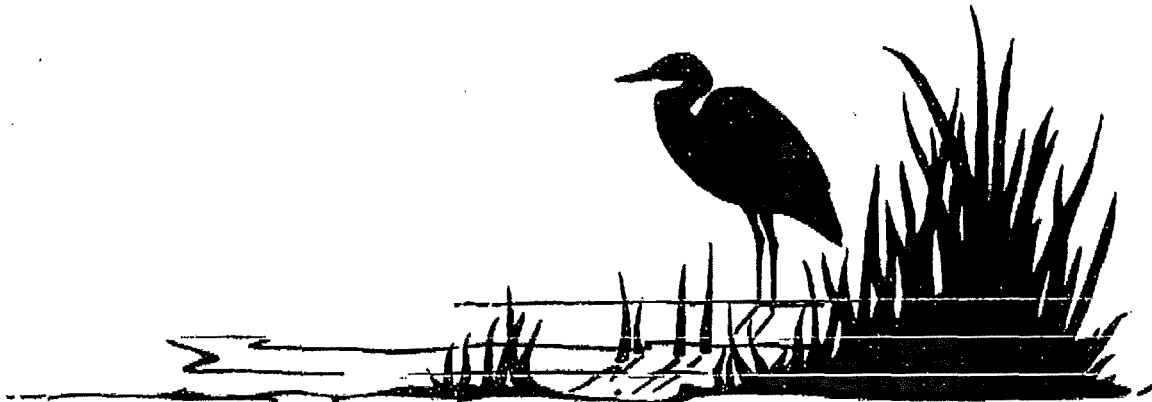

MANAGEMENT AND STORAGE OF SURFACE WATERS

JULY 1996

TABLE OF CONTENTS
PART D – PROJECT DESIGN AIDS

	PAGE
TABLE OF CONTENTS (PART D)	D-2
1. INTRODUCTION	D-3
2. RAINFALL	D-4
FIGURE D-1 – 24-HOUR, 2-YEAR RETURN PERIOD RAINFALL MAP . . .	D-5
FIGURE D-2 – 24-HOUR, 2.33 (MAF) RETURN PERIOD RAINFALL MAP .	D-6
FIGURE D-3 – 24-HOUR, 5-YEAR RETURN PERIOD RAINFALL MAP . . .	D-7
FIGURE D-4 – 24-HOUR, 10-YEAR RETURN PERIOD RAINFALL MAP . .	D-8
FIGURE D-5 – 24-HOUR, 25-YEAR RETURN PERIOD RAINFALL MAP . .	D-9
FIGURE D-6 – 24-HOUR, 50-YEAR RETURN PERIOD RAINFALL MAP . .	D-10
FIGURE D-7 – 24-HOUR, 100-YEAR RETURN PERIOD RAINFALL MAP .	D-11
RAINFALL DISTRIBUTION	D-12
TABLE D-1 – RAINFALL RATIOS (ACCUMULATED 24-HOUR TOTAL) . .	D-13

INTRODUCTION

The Southwest Florida Water Management District has developed "Part D, Project Design Aids" to provide consistency in the parameters used by District Staff in their review for environmental resource permitting of surface water management systems.

The design aids were selected solely on their ability to support the intent of the requirements in the environmental resource permitting rules for management and storage of surface waters and to identify some common and useful techniques for evaluating regulatory aspects of surface water management systems. The use of these design aids for purposes other than those stated in this manual may not be within the realm of their intended use and could result in a sub-standard design in some circumstances. It is therefore, incumbent upon the individual designer to exercise sound engineering judgment in the utilization of the information presented to ensure the overall integrity of the system and regulatory compliance.

Rainfall

A. Rainfall Duration

The Southwest Florida Water Management District is utilizing a 24-hour storm event as the standard storm duration for design and analysis purposes for water quantity permitting evaluation of surface water management systems.

B. Determination of Rainfall Depths

The Southwest Florida Management District has developed rainfall maps for a 24-hour storm duration for the 2-year, 2.33-year, 5-year, 10-year, 25-year, 50-year, and 100-year return periods, as shown in FIGURES D-1 through D-7. These rainfall maps will be utilized to determine a depth of rainfall in inches for a specific return period. This depth will be used for design and analysis purposes for evaluation of surface water and stormwater management systems.

C. Procedure for Determination of the Appropriate Rainfall Amount

1. The approximate location of the project site is to be located on the appropriate rainfall frequency map.
2. For projects located on an isohyets use the rainfall amount for that line.
3. For projects east of the most eastern isohyets use that eastern most isohyets as the rainfall amount.
4. For projects between two isohyets the rainfall amount is a straight line interpolation between the two isohyets. The next higher isohyets line may be used rather than interpolating.
5. For projects west of the most western isohyets use that western most isohyets as the rainfall amount.

SOUTHWEST FLORIDA WATER MANAGEMENT DISTRICT

Figure D-1
Twenty-Four-Hour Two-Year Return Period
Rainfall Map

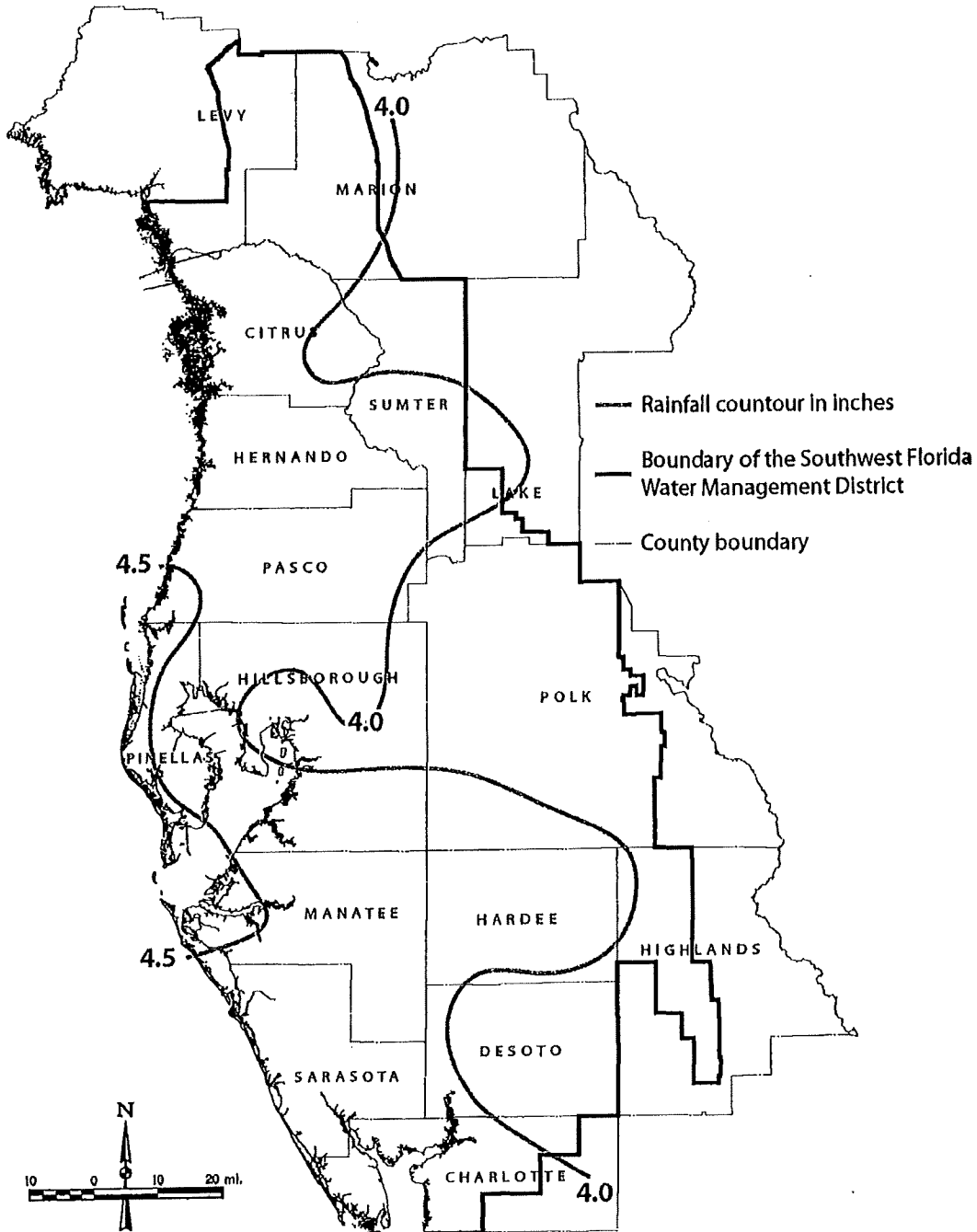

SOUTHWEST FLORIDA WATER MANAGEMENT DISTRICT

Figure D-2
Twenty-Four-Hour Mean Annual Return Period (2.33 years)
Rainfall Map

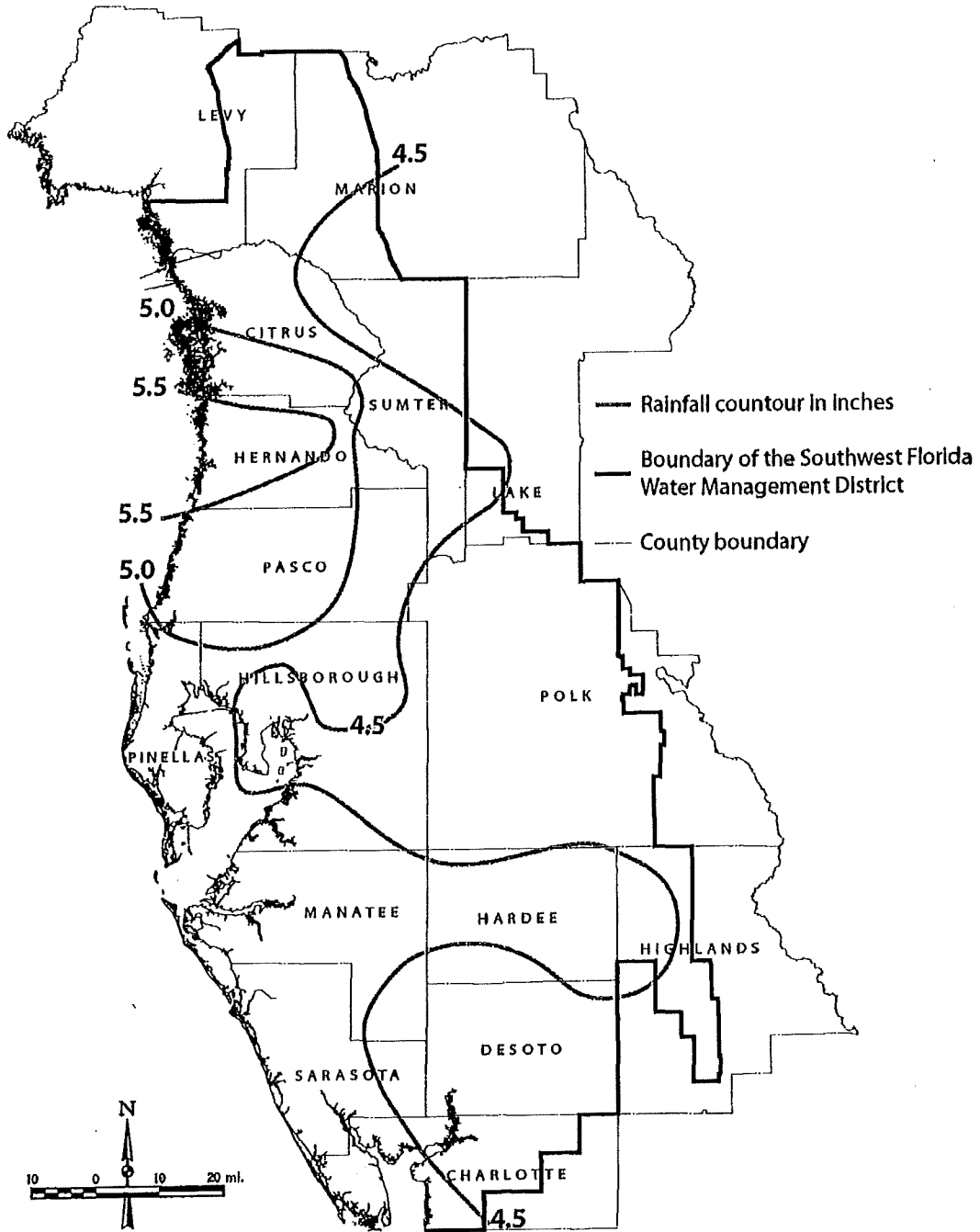

SOUTHWEST FLORIDA WATER MANAGEMENT DISTRICT

Figure D-3
Twenty-Four-Hour Five-Year Return Period
Rainfall Map

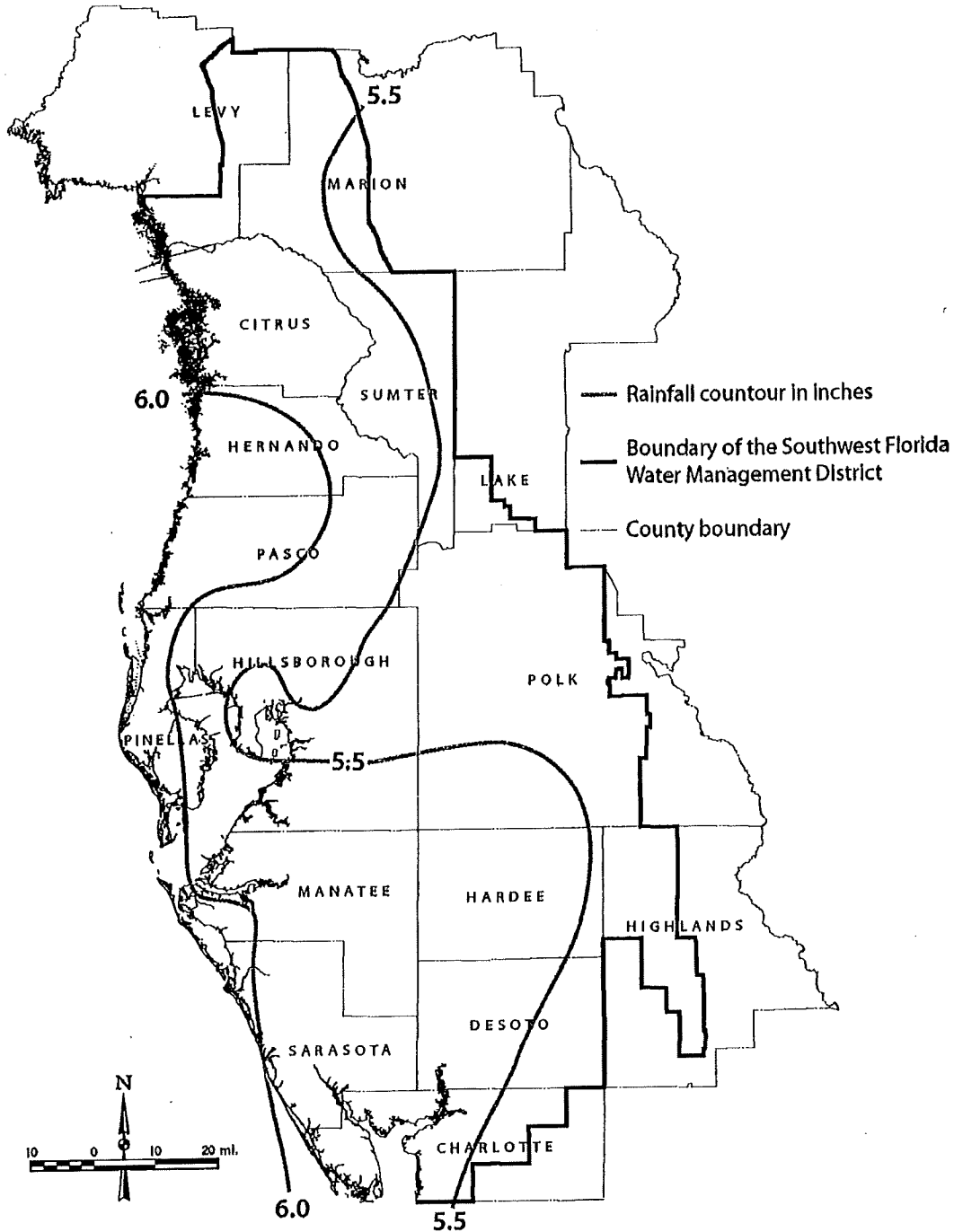

SOUTHWEST FLORIDA WATER MANAGEMENT DISTRICT

Figure D-4
Twenty-Four-Hour Ten-Year Return Period
Rainfall Map

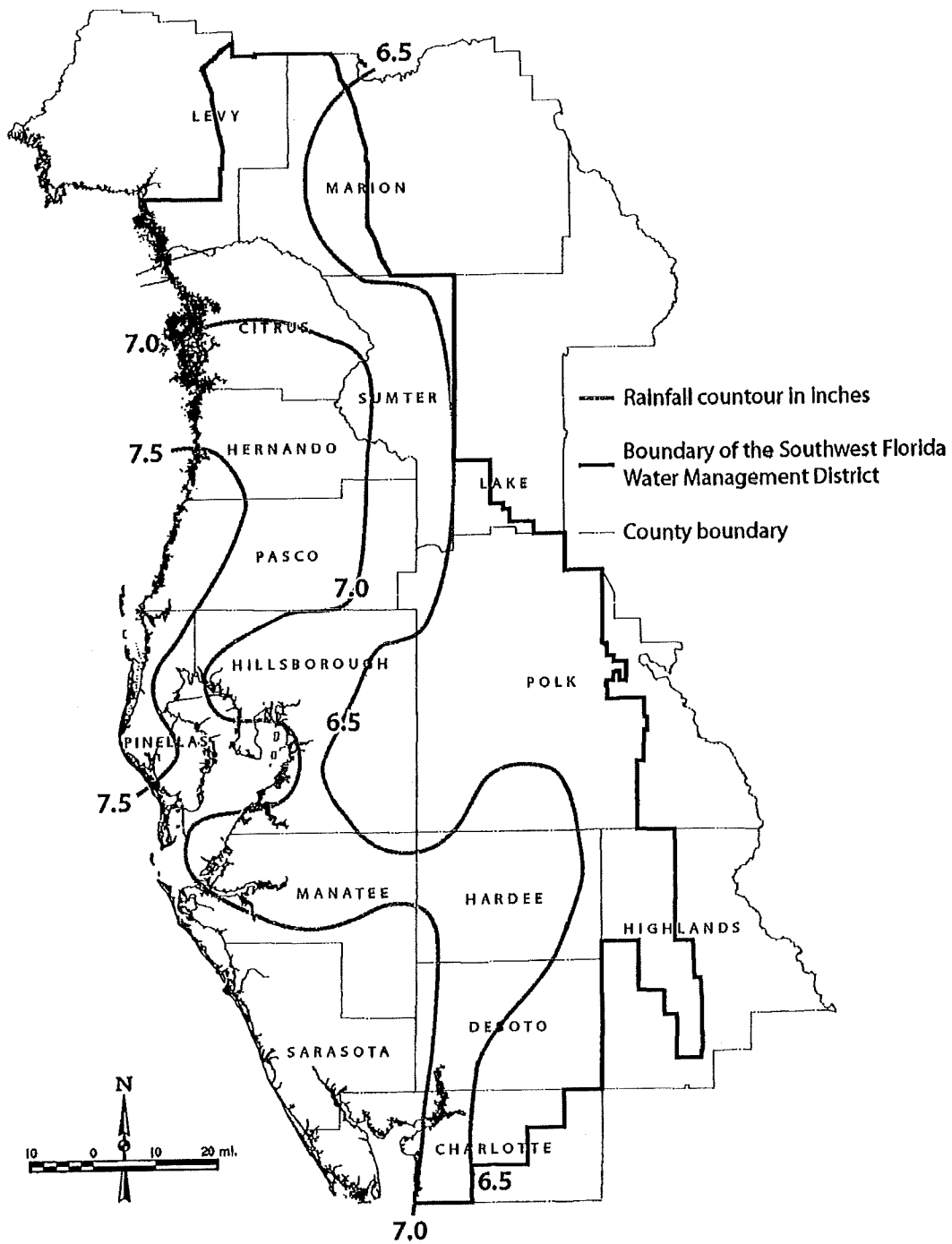

SOUTHWEST FLORIDA WATER MANAGEMENT DISTRICT

Figure D-5
Twenty-Four-Hour Twenty-Five-Year Return Period
Rainfall Map

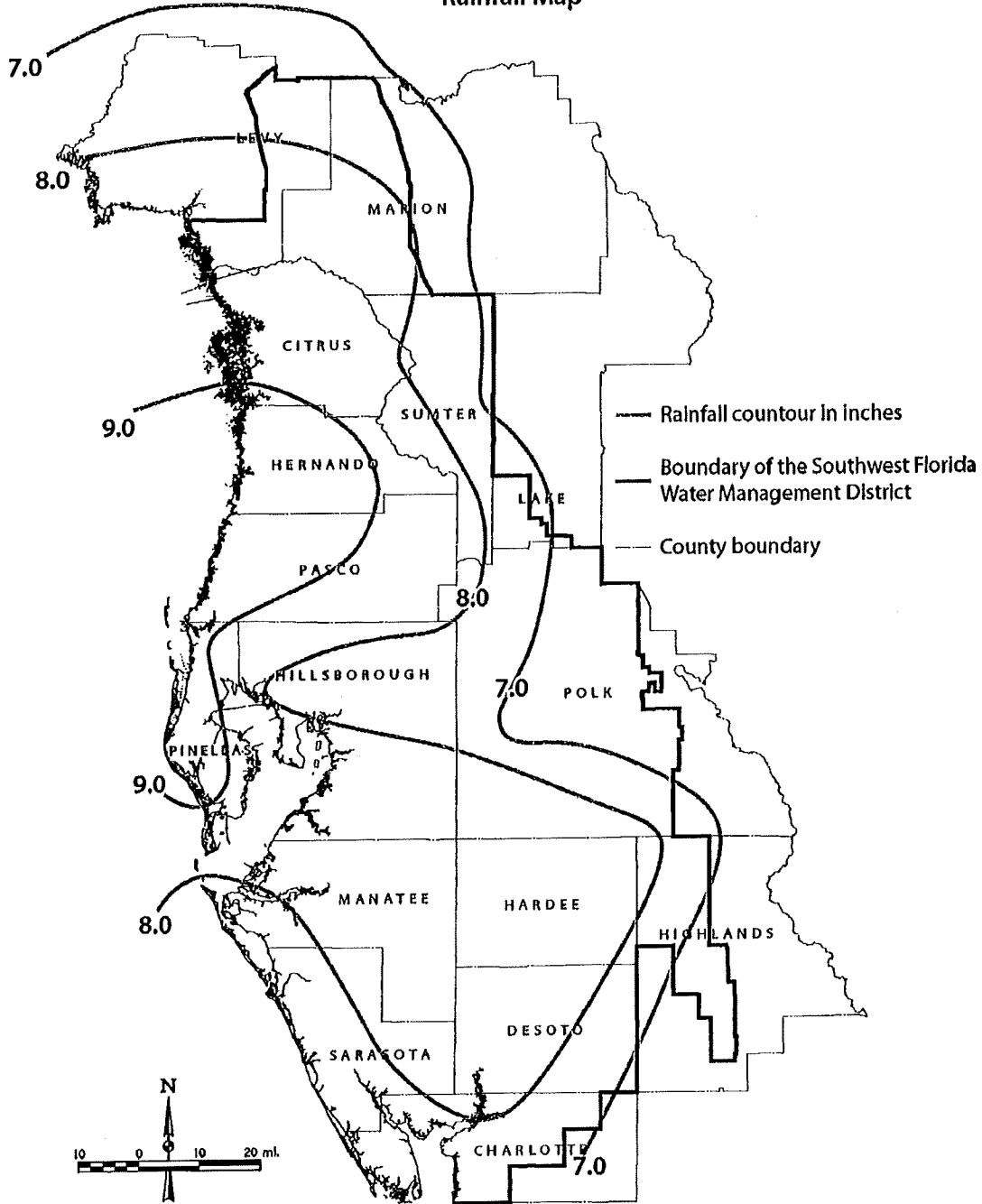

SOUTHWEST FLORIDA WATER MANAGEMENT DISTRICT

Figure D-6
Twenty-Four-Hour Fifty-Year Return Period
Rainfall Map

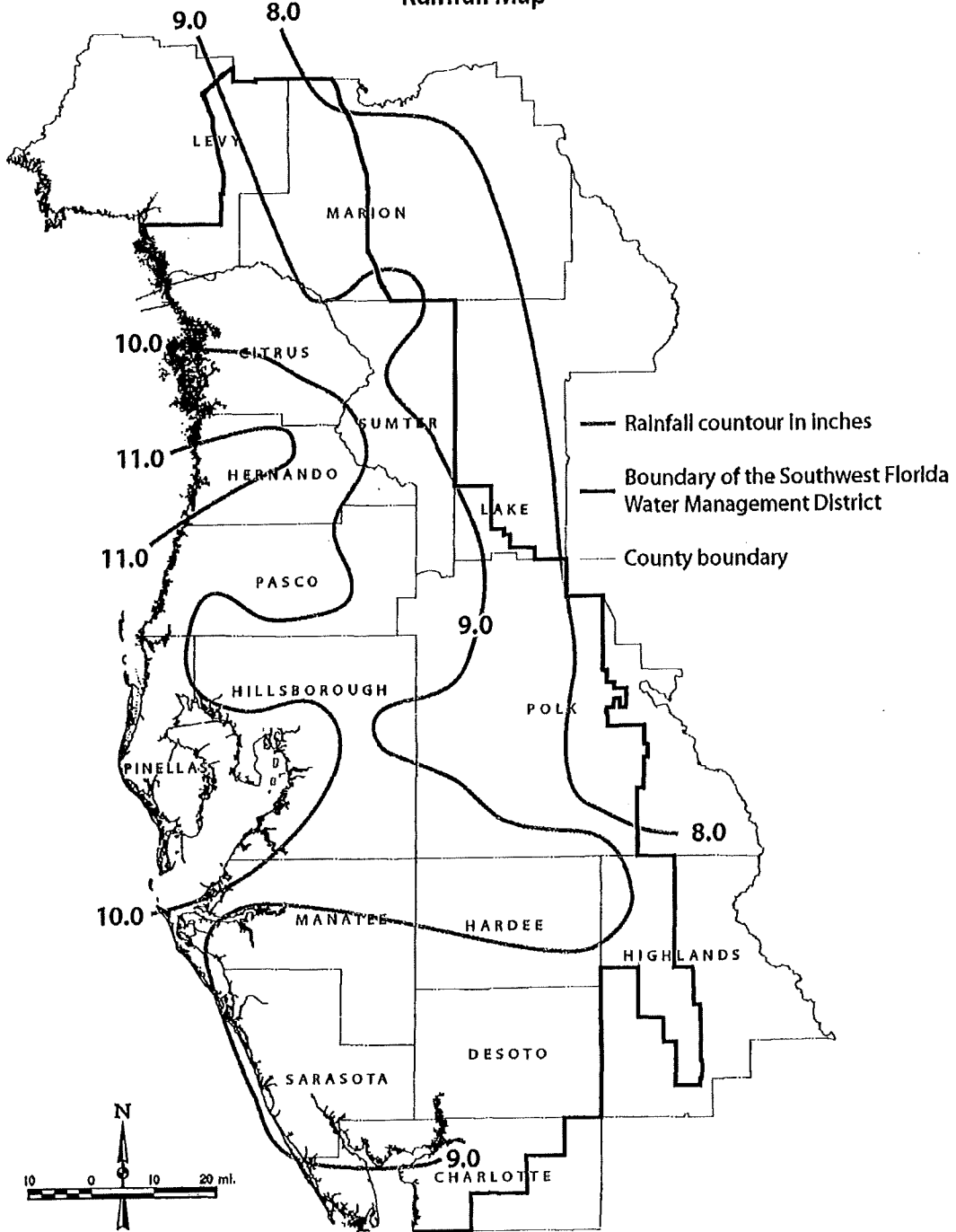

SOUTHWEST FLORIDA WATER MANAGEMENT DISTRICT

Figure D-7
Twenty-Four-Hour One-Hundred-Year Return Period
Rainfall Map

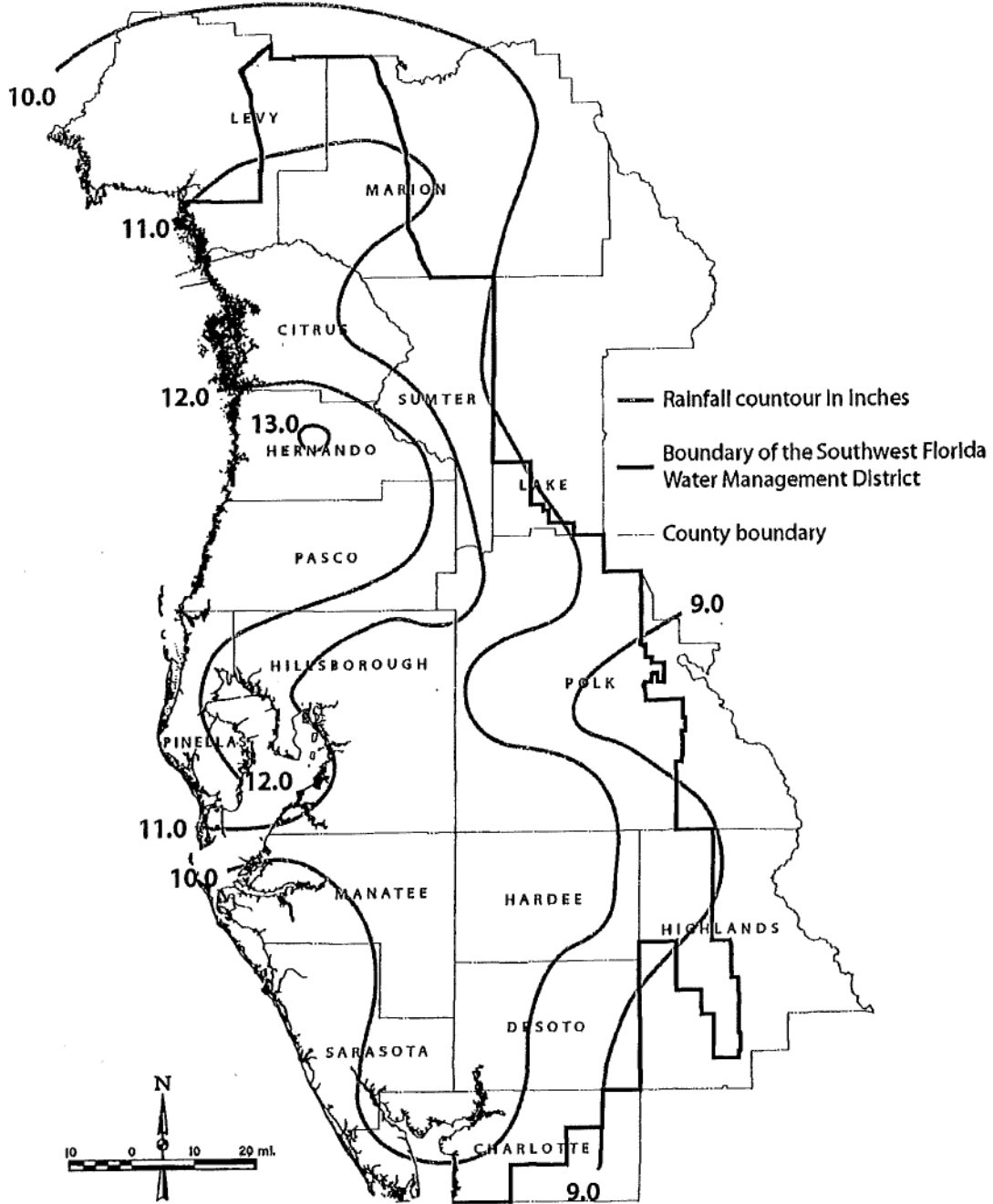

D. Rainfall Distribution

The USDA-Natural Resources Conservation Service [formerly Soil Conservation Service (SCS)] Type II Florida Modified Rainfall distribution shown in TABLE D-1 is recommended for use in the analysis of the water quantity portion of the rule. Other distributions which produce similar results may also be used if appropriate.

TABLE D-1
RAINFALL RATIOS (ACCUMULATED 24-HOUR TOTAL)

<u>TIME (HR)</u>	<u>SCS TYPE II FL. MODIFIED</u>
0.0	.000
0.5	.006
1.0	.012
1.5	.019
2.0	.025
2.5	.032
3.0	.039
3.5	.047
4.0	.054
4.5	.062
5.0	.071
5.5	.080
6.0	.089
6.5	.099
7.0	.110
7.5	.122
8.0	.134
8.5	.148
9.0	.164
9.5	.181
10.0	.201
10.5	.226
11.0	.258
11.5	.308
12.0	.607
12.5	.719
13.0	.757
13.5	.785
14.0	.807
14.5	.826
15.0	.842
15.5	.857
16.0	.870
16.5	.882
17.0	.893
17.5	.904
18.0	.913
18.5	.923
19.0	.931
19.5	.940
20.0	.948
20.5	.955
21.0	.962
21.5	.969
22.0	.976
22.5	.983
23.0	.989
23.5	.995
24.0	1.000

APPENDIX B

CONSERVATION WET DETENTION Alternative Treatment Design Technical Memorandum Concepts and Methods

BACKGROUND:

This memorandum provides guidelines for concepts and methods for the Conservation Wet Detention alternative treatment design option. Conservation Wet Detention utilizes a design pool¹ below the pond control elevation for achieving stormwater quality treatment and is a viable alternative to wet detention treatment systems designed based on the presumptive criteria in the Environmental Resource Permit Applicant's Handbook Volume II (AH VII.)

Reference 62-330.301(1)(e), Florida Administrative Code and AH VII, Sections 1.4, 4.0, and 4.1.a, 5.2 and 5.4.

DESCRIPTION:

Procedure:

Chapter 62-330, F.A.C. and the AH VII include provisions for applicants to incorporate alternative design options to demonstrate a project will meet the conditions for issuance set forth in Rules 62-330.301 and 62-330.302, F.A.C. One frequently used water quality design alternative is the Conservation Wet Detention treatment design.

The Conservation Wet Detention design method is based on fundamental components of the presumptive design guidelines for wet detention included in AH VII. Wet detention treatment systems provide water quality treatment using a design pool in association with water tolerant vegetation. If adequate residence time is provided, pollutants can be removed through settling, adsorption to soils and uptake by aquatic biota.

Section 5.4.1.e of the AH VII requires that the bottom elevation of a wet detention pond must be at least one foot below the control elevation. The intent of this requirement is to maintain a permanent wet pool which supports residual aquatic biota, dilutes influent stormwater runoff and extends the residence time of water passing through the system. Wet detention design guidelines in Sections 4.1 and 5.2 of the AH VII also require that wet detention pond discharge structures be designed with a gravity drawdown control device (bleed down device). The bleed down device allows no more than one-half of the detained treatment volume, stored between the overflow elevation down to seasonal high water level (SHWL) or control elevation, to discharge within the first 60 hours. Pool volume below the control elevation that intermixes with the SHWL is the permanent wet pool

CONSERVATION WET DETENTION: The following criteria provide an acceptable

¹ Design pool = treatment volume + permanent wet pool volume

alternative method of achieving design pool and gravity discharge configuration when it is justified to provide all or part of the treatment volume below SHWL or control elevation, without design pool bleed down (refer to Figure 1 and Table A for design and performance standards). If all other criteria are in compliance with the AH VII, monitoring will normally not be required.

- a) In the interest of water conservation, discharge devices below SHWL shall be avoided; and
- b) Design pool volume below the control elevation² to 8 feet depth³ must be equal to one inch of runoff plus the calculated volume based on average residence time of 14 days and average total rainfall during the wet season (122 days, June through September); and
- c) The minimum design pool volume below the control elevation to 8 feet depth must be no less than 1.667 inches of runoff from the contributing area; and
- d) Systems discharging directly into Outstanding Florida Waters (OFW) shall provide treatment volume 50% more than required for systems discharging to other receiving waters; and
- e) The gravity overflow weir shall be multi-stage, first having a "v"-notch⁴ or other gravity drawdown control device sized to discharge 1/2 inch of detention runoff from the contributing area in 24 hours with 10 inches maximum head (refer to Figure 3); and having a broad crested weir for higher discharges, including the 25 year, 24 hour event; and
- f) The control elevation ("v"-notch or other gravity control device) shall be above SHWL in the pond and above wet season tailwater in the receiving water, but no higher than 2 feet above SHWL; and
- g) For gravity discharge systems with treatment volume below SHWL, credit for water quantity (discharge attenuation) storage shall be allowed above control elevation and SHWL, if the "v"-notch or other gravity control device meets the requirements of e) above, and Section 5.2.a of the AH VII; and

² Longer residence time associated with the design pool for a wet detention system without a bleed down device is presumed to offset the benefits of extended detention drawdown of treatment volume by a bleed down device.

³ Pond bottom depth may be more or less 8 feet below control elevation, but permanent wet pool volume credit is limited to no deeper than 8 feet, since stratification and low light penetration may hamper proper mixing and biological processes below this depth. A maximum bottom depth of 12 feet is recommended to minimize the potential for anaerobic conditions and release of nutrients and metals from bottom sediments. Lesser depths are desirable, especially for small ponds.

⁴ The "v"-notch weir sized as stated creates a minimum pond area and fluctuation to enhance surface aeration, circulation and mixing in the design pool. The minimum pond area is equivalent to 5% of the contributing area, as recommended by Reference 1.

- h) At least 35% of the pond bottom, based on area at control elevation, must extend below SHWL to help sustain the required littoral area; and the 35% littoral area shall extend 2 feet maximum below the control elevation; and

Wet detention systems shall be specifically designed to maximize circulation, mixing and residence time of inflow within the design pool by means such as: maximum separation of inflow and outflow points, locating inflow inverts below the control elevation, use of multi-cell ponds or flow baffles and other locally effective means to avoid "dead" storage areas.

EXAMPLES:

AGRICULTURAL EXAMPLE

CALCULATION OF WET DETENTION DESIGN POOL VOLUME

Given: A citrus grove project near Arcadia, FL.; Project area = drainage area = 320 Ac.; Composite Rational runoff coefficient = 0.30; Discharge to Class III waters from a wet detention system.

- Required:
1. Calculate the treatment volume; and
 2. Calculate the permanent wet pool volume to be retained below the control elevation to 8 feet depth. It must be the greater of: a) the volume calculated to provide an average residence time of 14 days based on average total wet season rainfall of 31.04 inches; or, b) the volume produced by 0.667 inches of runoff from the contributing area; and
 3. Calculate the average minimum pond area.

1. Calculate the treatment volume (Q) as 1 inch of runoff -

$$(Q) = (320 \text{ Ac.}) (1 \text{ inch}) (1 \text{ ft./12 in.}) = \mathbf{26.67 \text{ Ac.-ft.(AF)}}$$

2. Calculate the permanent wet pool volume (V_B) -

a) Based on 14 day residence volume (V_R) -

$$(V_R) = (A) (C) (P) (R) (1 \text{ ft./12 in.})$$

Where,

(A) = Project area = drainage area = 320 Ac.

(C) = Composite Rational runoff coefficient = 0.30

(P) = Historic average wet season rainfall rate for Arcadia, Bradenton, Brooksville, Lakeland and Ocala gauging stations = (31.04 in./122 days)

(R) = Residence time = 14 days

$$(V_R) = (320) (0.30) (31.04/122) (14) (1/12) = \mathbf{28.50 \text{ AF}}$$

NOTE: Refer to Figure 2 for graphic solution of 14 day residence volumes for various project types and sizes.

b) As 0.667 inches of runoff (V_{min}) -

$$(V_{min}) = (320 \text{ Ac.}) (0.667 \text{ inch}) (1 \text{ ft./12 in.}) = \mathbf{17.78 \text{ AF}}$$

Since (V_R) is more than (V_{min}), **28.50 AF** is correct for permanent wet pool volume (V_B) in this case.

Therefore, the wet detention system design pool volume
= (Q) **26.67 AF** + (V_B) **28.50 AF** = **55.17 AF**.

3. Calculate the average minimum pond area (A_s) -

Based on treatment volume below control elevation of "v"-notch weir, 1/2 inch runoff and 10 in. maximum head or based on design pool volume at maximum depth -

1) Based on 10 in. **maximum** head on the "v"-notch:

$$(V_w) = (320 \text{ Ac.}) (0.50 \text{ inch}) (1 \text{ ft./12 in.}) = 13.33 \text{ AF}$$

$$(A_s) = (13.33 \text{ AF}/0.833 \text{ ft.}) = \mathbf{16.00 \text{ Ac.}}$$

2) Based on design pool volume [(Q) + (V_B) = 55.17 AF] at maximum depths:

$$55.17 \text{ AF} = [(0.35)(2 \text{ ft.})(A_s)] + [(0.65)(8 \text{ ft.})(A_s)]$$

$$(A_s) = (55.17 \text{ AF})/(5.9) = \mathbf{9.35 \text{ Ac.}}$$

Check Max. head (H) = (V_w)/(A_s),

$$(V_w) = 13.33 \text{ AF}; (A_s) = 9.35 \text{ Ac.}$$

$$(H) = (13.33/9.35) = 1.425 \text{ Ft.} = 17.1 \text{ in.} > 10 \text{ in.}$$

Therefore, the correct minimum pond area is **16.00 Ac.**

COMMERCIAL EXAMPLE (WITH OFFSITE RUNOFF) **CALCULATION OF WET DETENTION DESIGN POOL VOLUME**

Given: A shopping plaza project near Oneco, FL.; Project area = 16 Ac.; Drainage area = 18 Ac.; Composite Rational runoff coefficients: project site = 0.90; offsite = 0.45; drainage area = 0.85; Discharge to Class III waters from a wet detention system.

Required: 1. Calculate the treatment volume; and

2. Calculate the permanent wet pool volume to be retained below the control elevation to 8 feet depth. It must be the greater of: a) the volume calculated to provide an average residence time of 14 days based on average total wet season rainfall of 31.04 inches; or, b) the volume produced by 0.667 inches of runoff from the contributing area; and

3. Calculate the average minimum pond area.

1. Calculate the treatment volume (Q)

a) For project site, as 1 inch of runoff (Q_P) -

$$(Q_P) = (16 \text{ Ac.}) (1 \text{ inch}) (1 \text{ ft./12 in.}) = \mathbf{1.33 \text{ Ac.-ft.(AF)}}$$

b) For offsite, as runoff from first inch of rainfall (Q_O) -

$$(Q_O) = (2 \text{ Ac.}) (1 \text{ inch}) (0.45) (1 \text{ ft./12 in.}) = \mathbf{0.08 \text{ AF}}$$

$$\text{Therefore, } (Q) = (Q_P) \mathbf{1.33 \text{ AF}} + (Q_O) \mathbf{0.08 \text{ AF}} = \mathbf{1.41 \text{ AF}}$$

2. Calculate the permanent wet pool volume (V_B) -

a) Based on 14 day residence volume (V_R) -

$$(V_R) = (A) (C) (P) (R) (1 \text{ ft./12 in.})$$

Where,

(A) = Project site + offsite = drainage area = 18 Ac.

(C) = Composite Rational runoff coefficient = 0.85

(P) = Historic average wet season rainfall rate for Arcadia, Bradenton, Brooksville, Lakeland and Ocala gauging stations = (31.04 in./122 days)

(R) = Residence time = 14 days

$$(V_R) = (18) (0.85) (31.04/122) (14) (1/12) = \mathbf{4.54 \text{ AF}}$$

NOTE: Refer to Figure 2 for graphic solution of 14 day residence volumes for various project types and sizes.

b) As 0.667 inches of runoff (V_{min}) -

$$(V_{min}) = (18 \text{ Ac.}) (0.667 \text{ inch}) (1 \text{ ft./12 in.}) = \mathbf{1.00 \text{ AF}}$$

Since (V_R) is more than (V_{min}), **4.54 AF** is correct for permanent wet pool volume (V_B) in this case.

Therefore, the wet detention system design pool volume
= (Q) **1.41 AF** + (V_B) **4.54 AF** = **5.95 AF**.

3. Calculate the average minimum pond area (A_s) -

Based on treatment volume below control elevation of "v"-notch weir, 1/2 inch runoff and 10 in. maximum head or based on design pool volume at maximum depth -

1) Based on 10 in. **maximum** head on the "v"-notch:

$$(V_w) = (18 \text{ Ac.}) (0.50 \text{ inch}) (1 \text{ ft./12 in.}) = 0.75 \text{ AF}$$

$$(A_s) = (0.75 \text{ AF}/0.833 \text{ ft.}) = \mathbf{0.90 \text{ Ac.}}$$

2) Based on design pool volume $[(Q) + (V_B) = 5.95 \text{ AF}]$ at maximum depths (i.e., 35% @ 2' and 65% @ 8' depth):

$$5.95 \text{ AF} = [(0.35)(2 \text{ ft.})(A_s)] + [(0.65)(8 \text{ ft.})(A_s)]$$

$$(A_s) = (5.95 \text{ AF})/(5.9) = \mathbf{1.01 \text{ Ac.}}$$

Check Max. head (H) = $(V_w)/(A_s)$,

$$(V_w) = 0.75 \text{ AF}; (A_s) = 1.01 \text{ Ac.}$$

$$(H) = (0.75/1.01) = 0.743 \text{ Ft.} = 8.9 \text{ in.} < 10 \text{ in.}$$

Therefore, the correct minimum pond area is **1.01 Ac.**

RESIDENTIAL EXAMPLE (WITH DISCHARGE TO OFW)
CALCULATION OF WET DETENTION DESIGN POOL VOLUME

Given: A residential subdivision project near Sarasota, FL.; Project area = Drainage Area = 40 Ac.; Composite Rational runoff coefficient = 0.85; Discharge to OFW from a wet detention system.

Required: 1. Calculate the treatment volume; and

2. Calculate the permanent wet pool volume to be retained below the control elevation to 8 feet depth. It must be the greater of: a) the volume calculated to provide an average residence time of 14 days based on average total wet season rainfall of 31.04 inches; or, b) the volume produced by 0.667 inches of runoff from the contributing area; and

3. Calculate the average minimum pond area.

1. Calculate the treatment volume (Q)

a) For project site, as 1 inch of runoff (Q_P) -

$$(Q_P) = (40 \text{ Ac.}) (1 \text{ inch}) (1 \text{ ft./12 in.}) = \mathbf{3.33 \text{ Ac.-ft.(AF)}}$$

b) For OFW discharge, provide 50% more treatment volume

$$(Q_{ofw}) = 3.33 \text{ AF} + 3.33\text{AF}(0.50) = \mathbf{5.00 \text{ AF}}$$

2. Calculate the permanent wet pool volume (V_B) -

a) Based on 14 day residence volume (V_R) -

$$(V_R) = (A) (C) (P) (R) (1 \text{ ft./12 in.})$$

Where,

(A) = Project site = drainage area = 40 Ac.

(C) = Composite Rational runoff coefficient = 0.85

(P) = Historic average wet season rainfall rate for Arcadia, Bradenton, Brooksville, Lakeland and Ocala gauging stations = (31.04 in./122 days)

(R) = Residence time = 14 days

$$(V_R) = (40) (0.85) (31.04/122) (14) (1/12) = \mathbf{10.09 \text{ AF}}$$

NOTE: Refer to Figure 2 for graphic solution of 14 day residence volumes for various project types and sizes.

b) As 0.667 inches of runoff (V_{min}) -

$$(V_{min}) = (40 \text{ Ac.}) (0.667 \text{ inch}) (1 \text{ ft./12 in.}) = \mathbf{2.22 \text{ AF}}$$

Since (V_R) is more than (V_{min}), **10.09 AF** is correct for permanent wet pool volume (V_B) in this case.

Therefore, the wet detention system design pool volume
= (Q_{ofw}) **5.00 AF** + (V_B) **10.09 AF** = **15.09 AF**.

3. Calculate the average minimum pond area (A_s) -

Based on treatment volume below control elevation of "v"-notch weir, 1/2 inch runoff and 10 in. maximum head or based on design pool volume at maximum depth -

3) Based on 10 in. **maximum** head on the "v"-notch:

$$(V_w) = (40 \text{ Ac.}) (0.50 \text{ inch}) (1 \text{ ft./12 in.}) = 1.67 \text{ AF}$$

$$(A_s) = (1.67 \text{ AF}/0.833 \text{ ft.}) = \mathbf{2.00 \text{ Ac.}}$$

4) Based on design pool volume [(Q_{ofw}) + (V_B) = 15.09 AF] at maximum depths (i.e., 35% @ 2' and 65% @ 8' depth):

$$15.09 \text{ AF} = [(0.35)(2 \text{ ft.})(A_s)] + [(0.65)(8 \text{ ft.})(A_s)]$$

$$(A_s) = (15.09 \text{ AF})/(5.9) = \mathbf{2.56 \text{ Ac.}}$$

Check Max. head (H) = $(V_w)/(A_s)$,

$$(V_w) = 1.67 \text{ AF}; (A_s) = 2.56 \text{ Ac.}$$

$$(H) = (1.67/2.56) = 0.652 \text{ Ft.} = 7.8 \text{ in.} < 10 \text{ in.}$$

Therefore, the correct minimum pond area is **2.56 Ac.**

REFERENCES:

1. "The Florida Development Manual: A Guide to Sound Land and Water Management," June 1988, FDER
2. "Design of Urban Runoff Quality Controls," Proceedings of an Engineering Foundation Conference held in July 1988, American Society of Civil Engineers, 1989

ATTACHMENT(S):

- Figure 1 Conservation Wet Detention Discharge Structure End View and Discharge Structure Instream View
- Figure 2 14 Day Residence Volume in Acre-Feet Per Acre of Contributing Area – DISTRICT-WIDE.
- Figure 3 Discharge Equations for "V"-Notch and Rectangular Notch Weirs
- Table A Conservation Wet Detention, Conservation Design Pool Below SHWL Without Discharge.

FIGURE 1
Conservation Wet Detention
 Discharge Structure End View and Discharge Structure Instream View

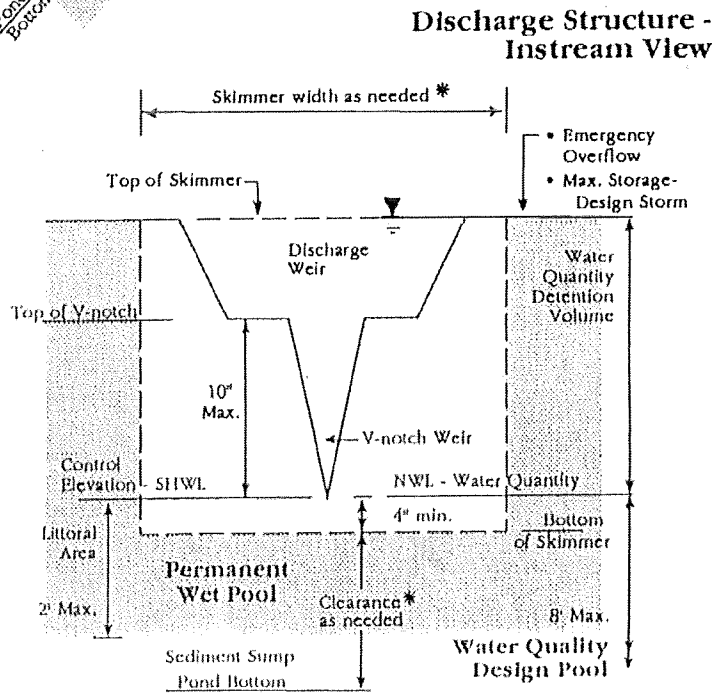
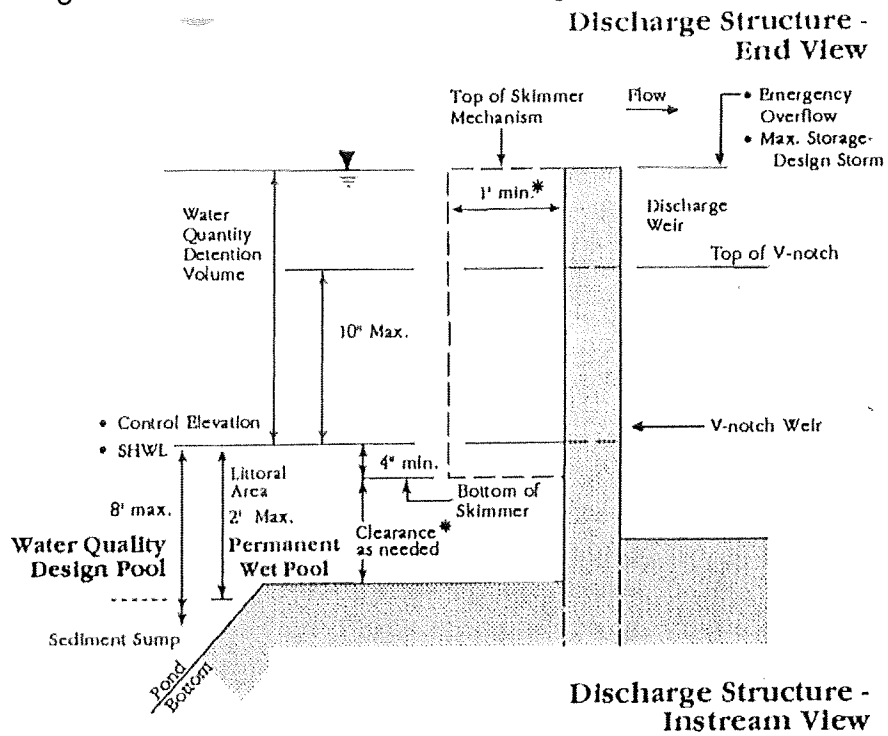

* Skimmer clearances must be adequate to avoid excessive constriction of flow during the design storm.

Table A
Conservation Wet Detention
 Conservation Design Pool Below SHWL Without Discharge

MANMADE WET DETENTION DESIGN AND PERFORMANCE STANDARDS	
Treatment Volume/Depth	1" runoff from on-site; runoff from first 1" of rainfall from offsite
Draw Down Time	Not required for treatment volume
Permanent Design Pool Volume	Rainy season 14 day residence vol. plus treatment vol.; min. 1.667 in. runoff
Other Criteria for System Design	<ul style="list-style-type: none"> • 35% littoral zone @ control elev.; concentrated at outfall • V-notch weir sized to discharge 1/2 in. runoff in 24 hrs., 10" max. flux. above SHWL/control elev. • Littoral zone 2' max. depth below control elevation • Design pool, 8' max. depth; 25% min. pond bottom below SHWL. • Sediment sump and skimmer usually required • Mulching or planting required if soils are unsuitable • Side slopes 4H:1V unless safety fenced • Inflow/outflow points must maximize circulation • Control elev. not lower than SHWL and tailwater, nor higher than 2' above SHWL.

FIGURE 2
14 Day Residence Volume in Acre-Feet Per Acre of Contributing Area –
DISTRICT-WIDE

14 Day Residence Volume in Acre-Feet per
 Acre of Contributing Area - DISTRICT WIDE

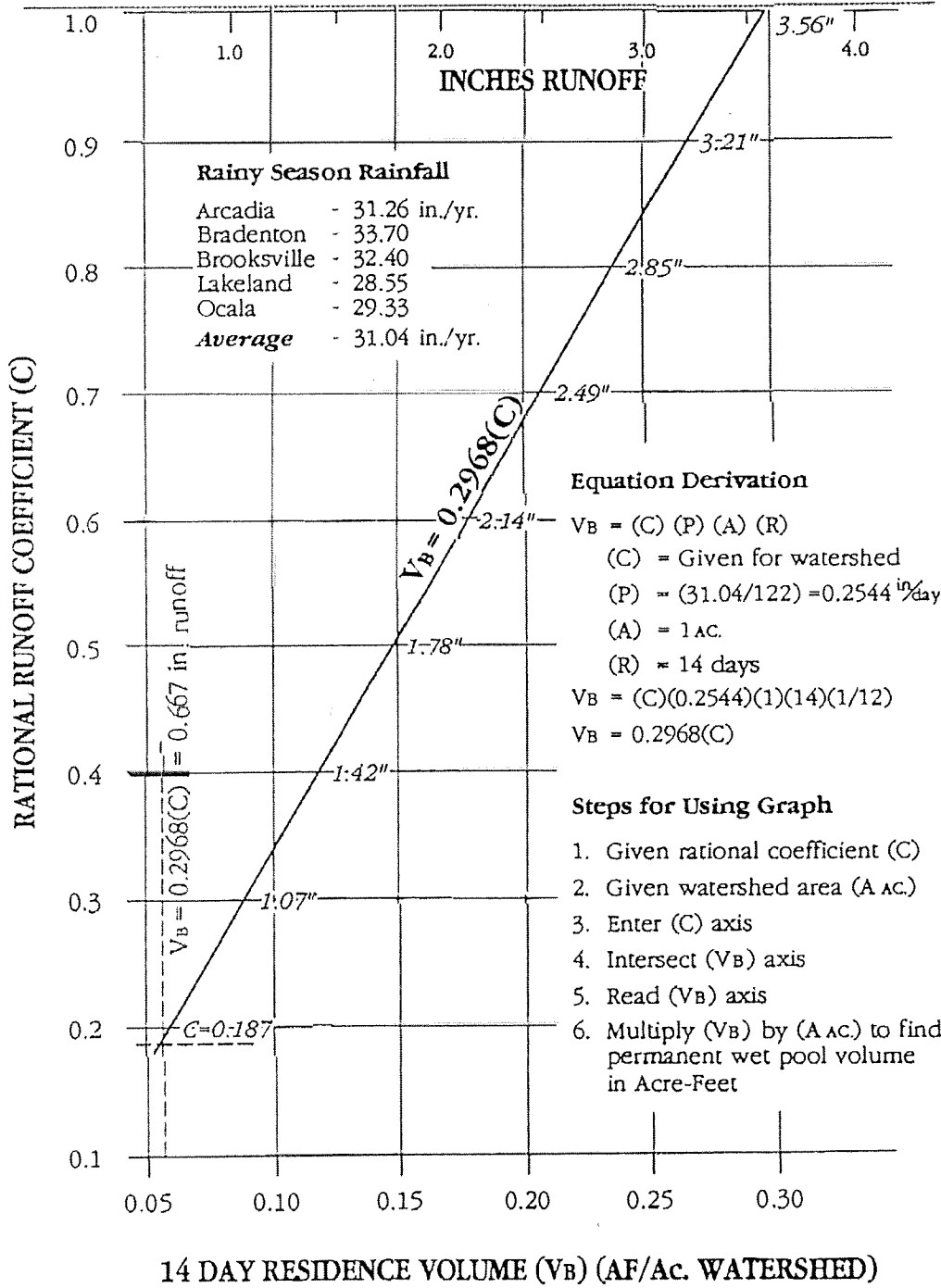

FIGURE 3
Discharge Equations for "V"-Notch and Rectangular Notch Weirs

"V"-Notch Weirs:



The total flow over a "v"-notch weir is approximated by the equation:

$$Q = C \tan(\theta/2)H^{5/2}$$

where the Coefficient of Discharge "C" is assumed to be 2.5 for v-notch weirs.

Rectangular Notch Weirs:

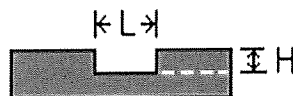

The total flow over a rectangular notch weir is approximated by the equation:

$$Q = C L H^{3/2}$$

where the Coefficient of Discharge "C" for a broad crested rectangular weir having a 6" breadth ranges between 2.8 and 3.3 for Head "H" ranging between 0.20 feet and 0.83 feet, respectively. [Reference Brater and King's Handbook of Hydraulics, Sixth Edition, Table 5-3, Page 5-40]

NOTE: Calculations for determining the size of a "v"-notch or rectangular notch weir to discharge a mixing volume in approximately 24-hours, should be based on a falling head analysis from the top of the weir notch down to an elevation no higher than 0.04 feet above the weir invert. The falling head analysis must also consider the pond stage – area data between the top of the weir notch and the weir invert elevation.

APPENDIX C

Figures Relating to Water Quality Provisions, Water Quantity Provisions and Retention Systems Within Sensitive Karst Areas

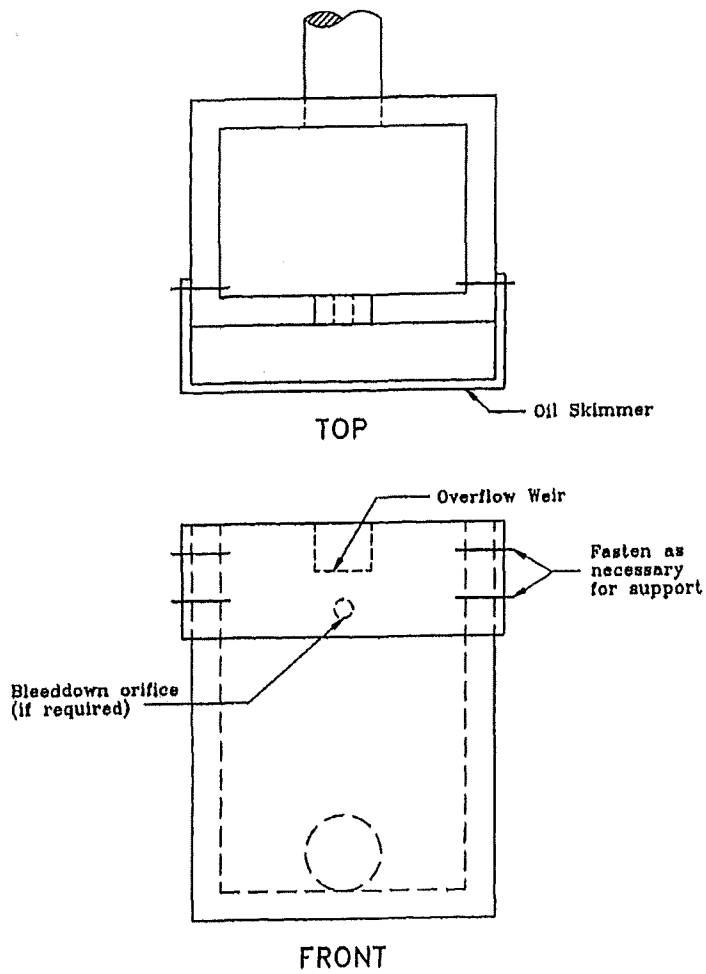

Figure 1. Oil Skimmer Detail for a Typical Outfall Structure (N.T.S.)

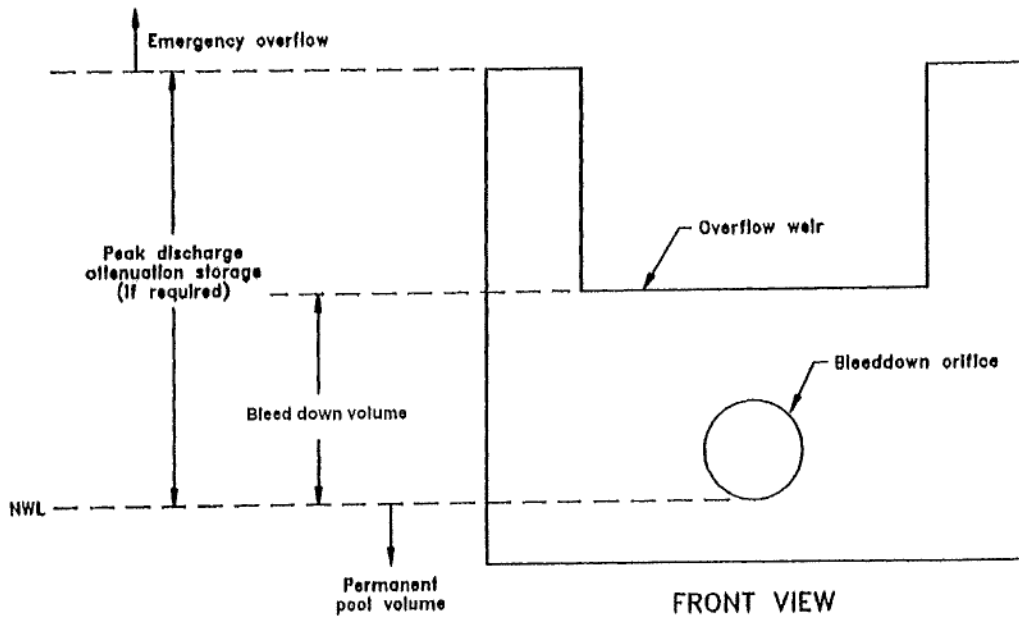

Figure 2. Typical Wet Detention Outfall Structure (N.T.S.)

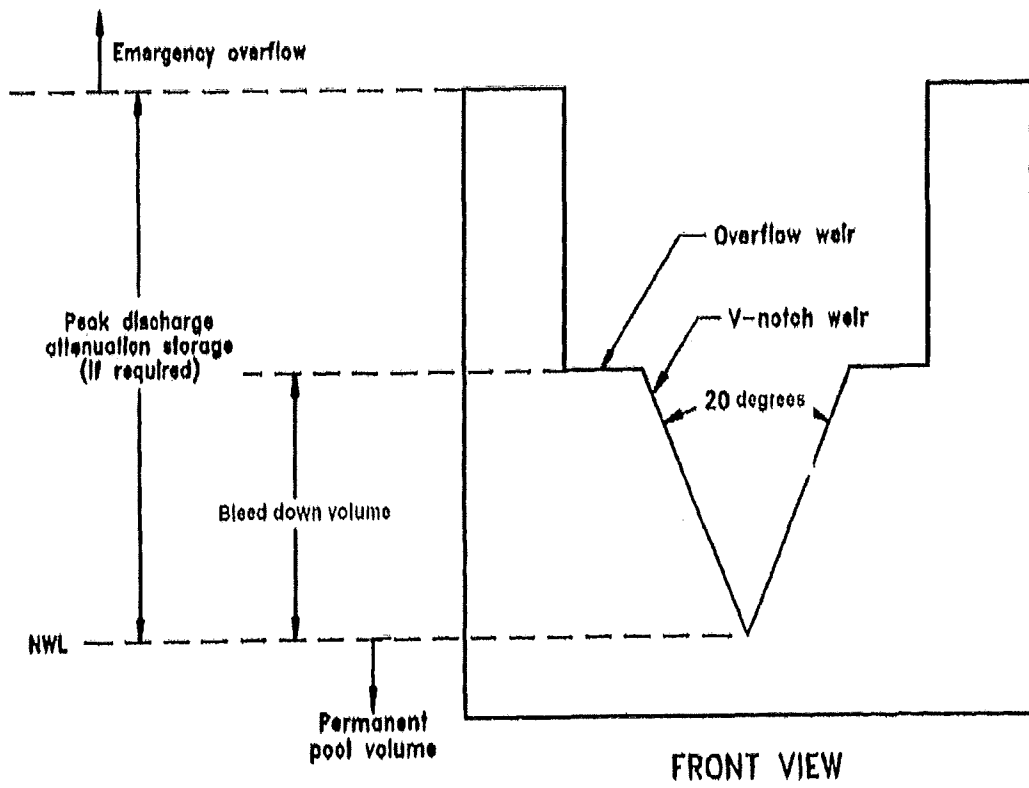

Figure 3. Typical Wet Detention Outfall Structure with "V"-notch Weir (N.T.S.)

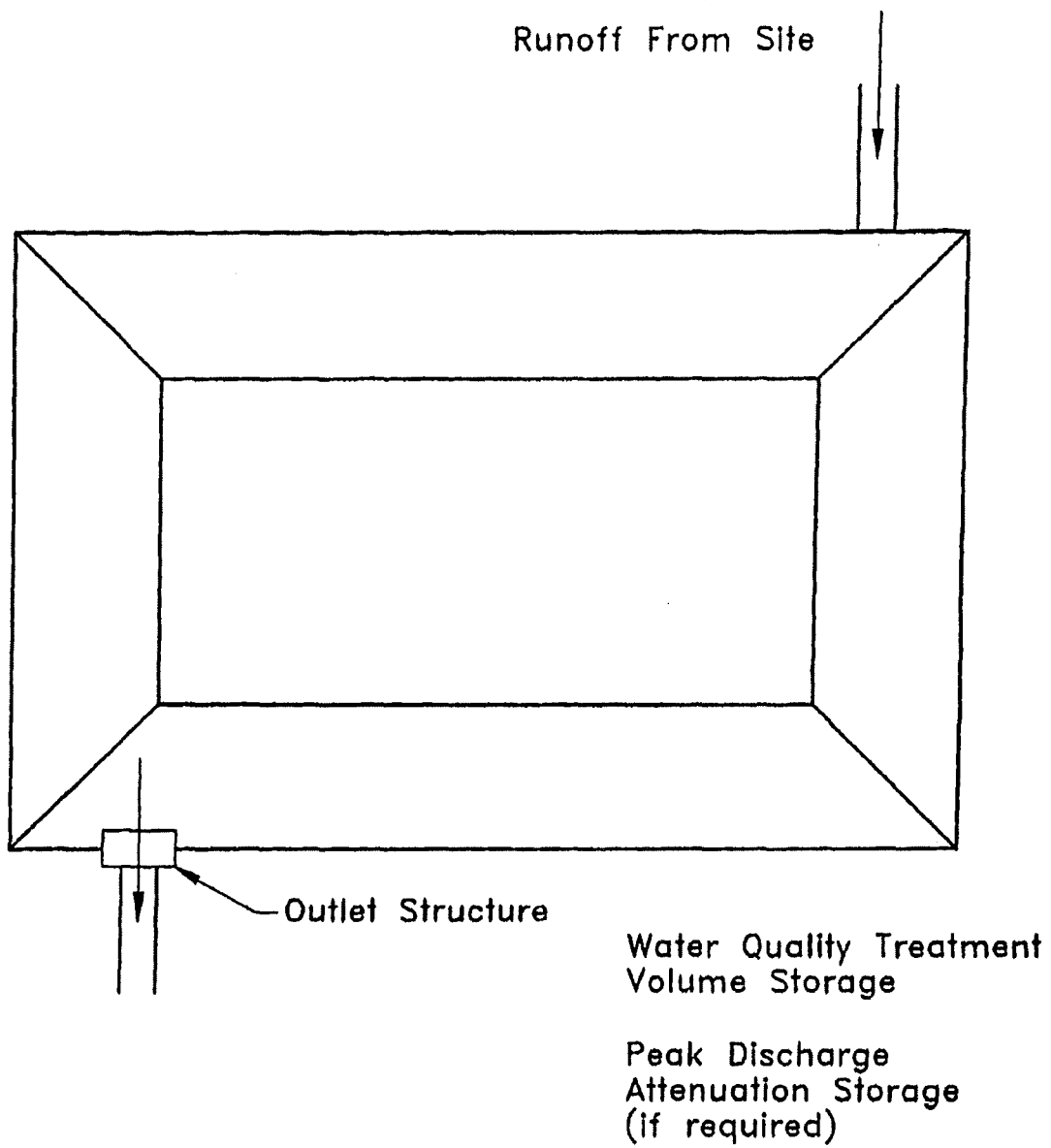

Figure 4. On-line treatment system.

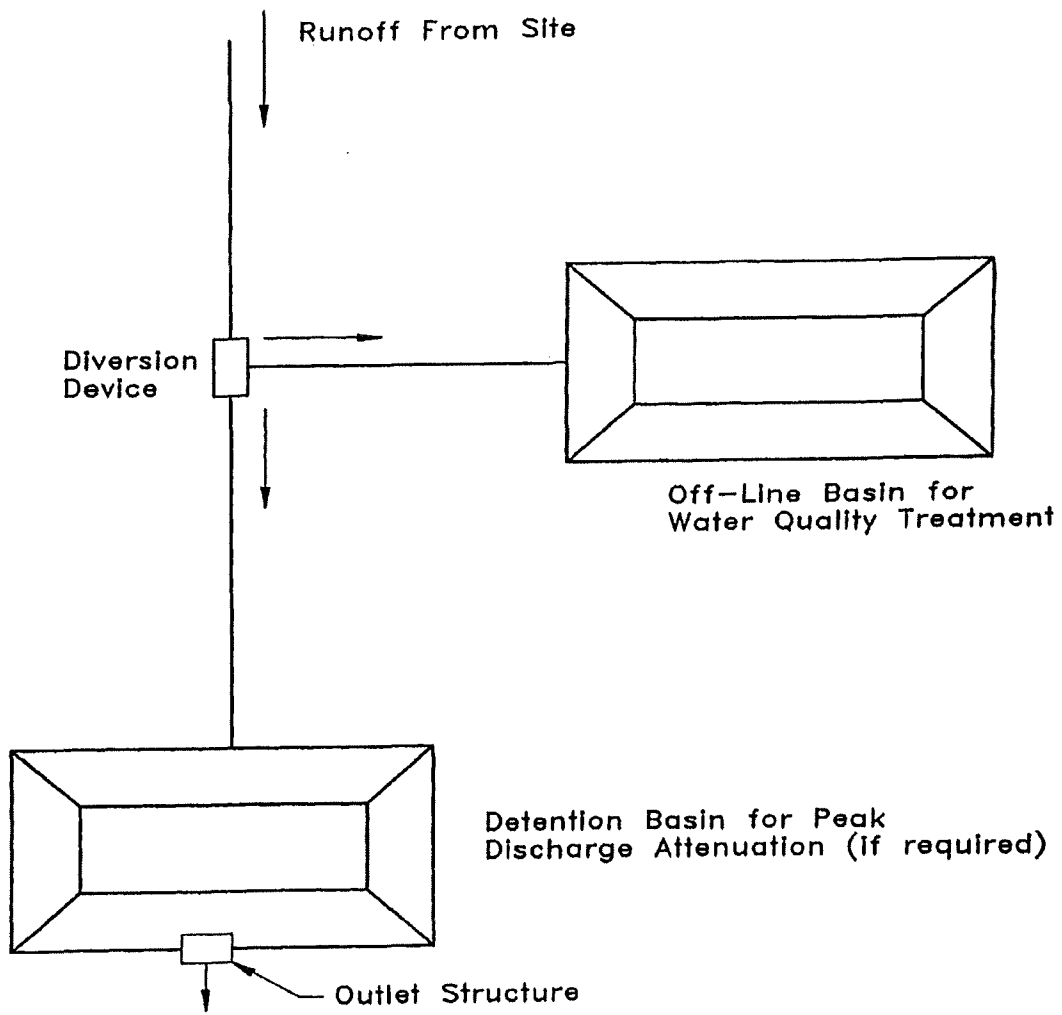

Figure 5. Off-line treatment system.

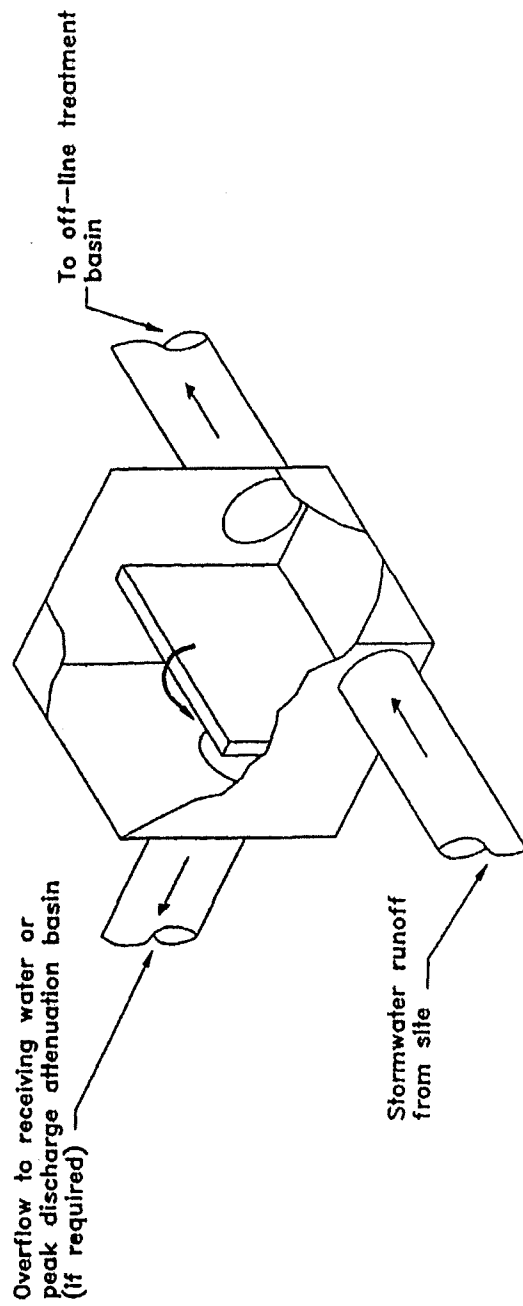

Figure 6. Diversion box (N.T.S.).

Generalized geologic section in Sensitive Karst Area with limestone at and near land surface

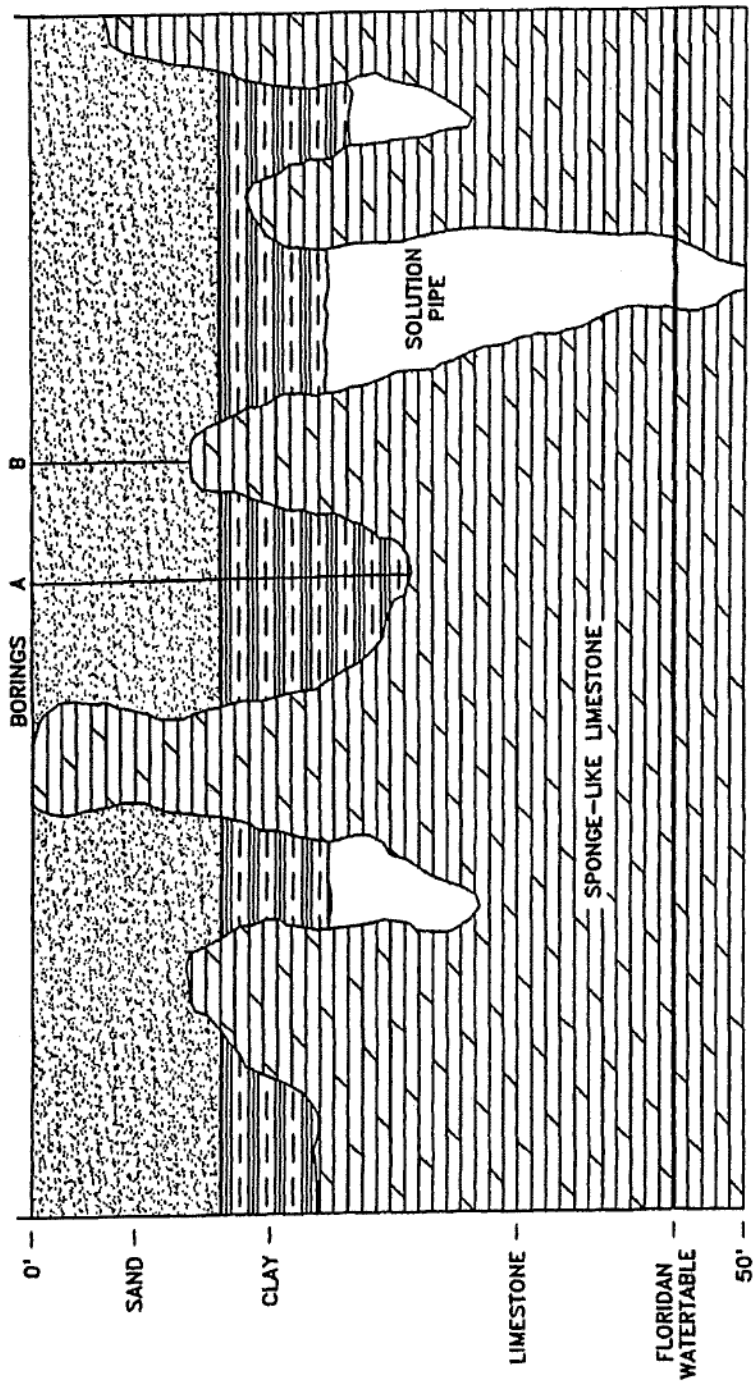

Figure 7. Generalized geologic section in Sensitive Karst Area with limestone at and near land surface

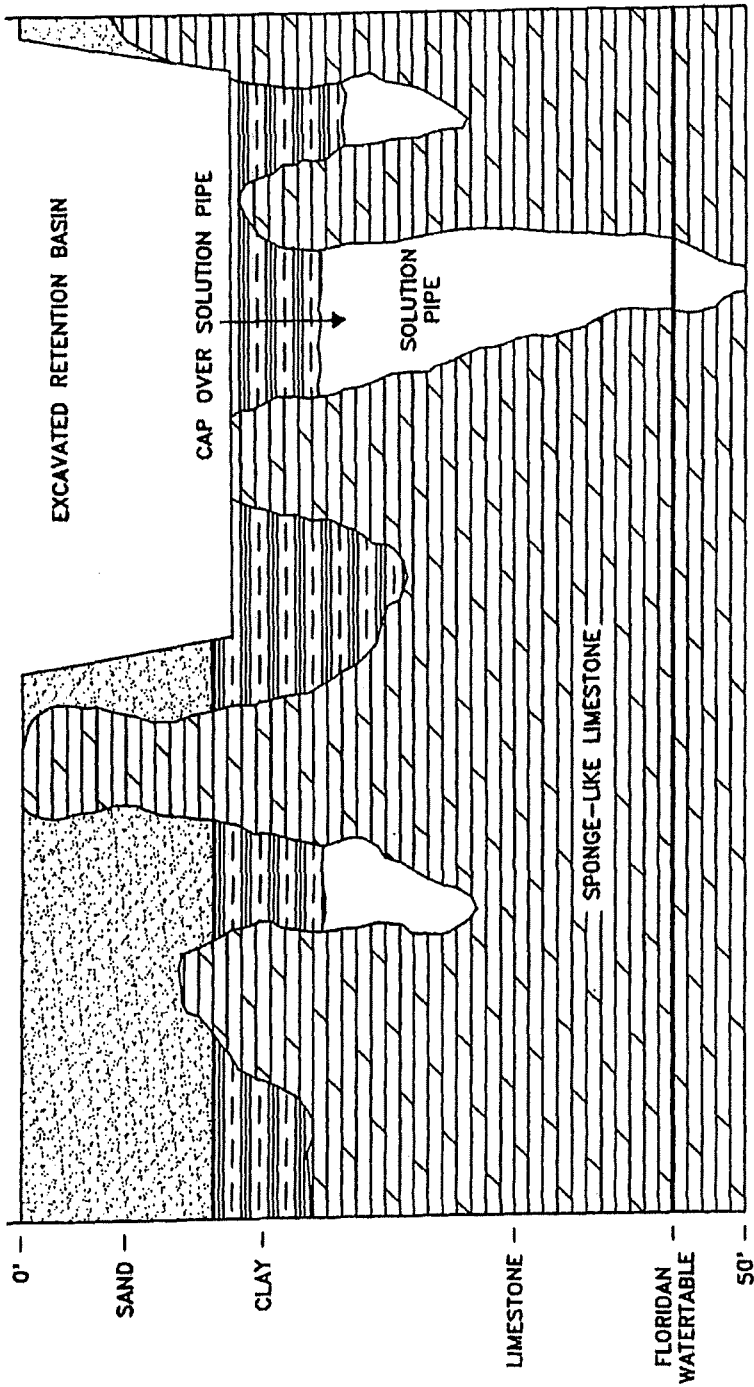

Figure 8. Retention basin added to Figure 7.

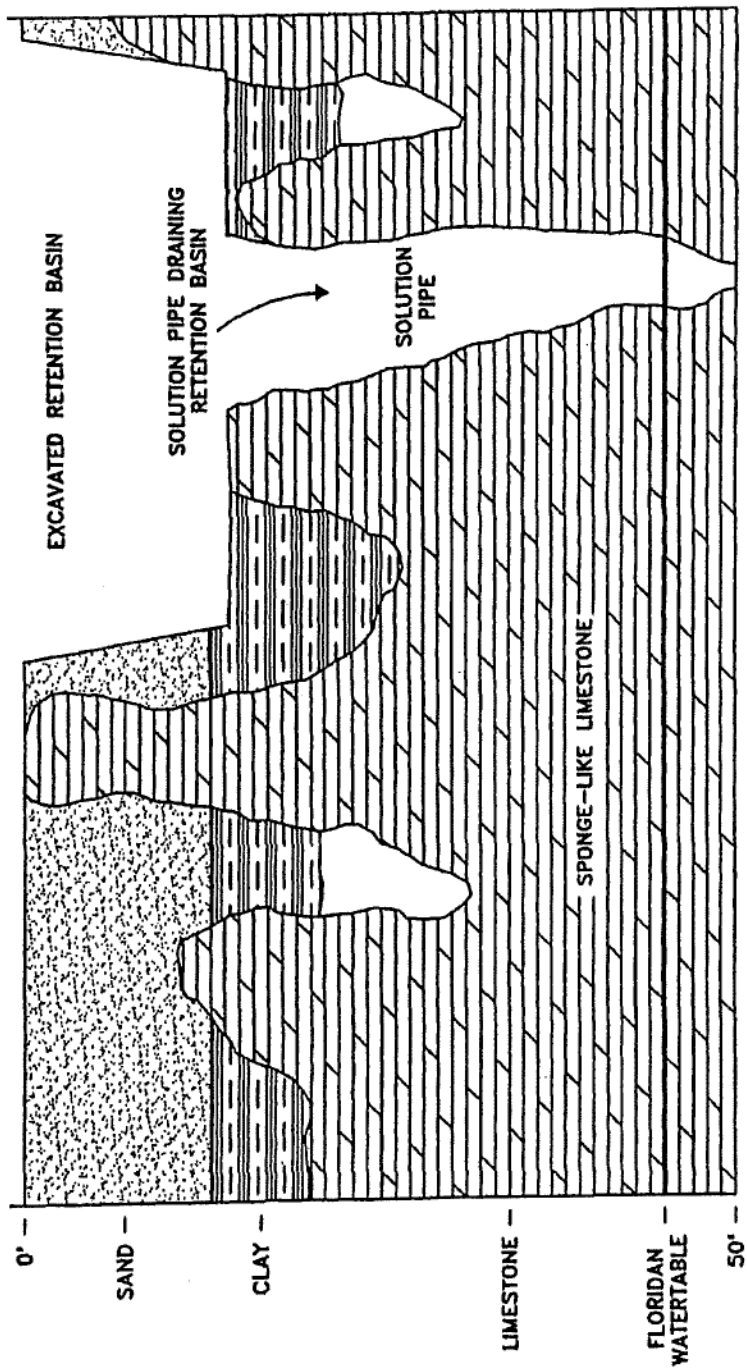

Figure 9. Retention pond with solution pipe

APPENDIX D

**OPERATING AGREEMENT CONCERNING REGULATION
UNDER PART IV, CHAPTER 373, F.S., BETWEEN
SOUTHWEST FLORIDA WATER MANAGEMENT DISTRICT AND
DEPARTMENT OF ENVIRONMENTAL PROTECTION**

Effective July 1, 2007

**OPERATING AGREEMENT CONCERNING
REGULATION UNDER PART IV, CHAPTER 373, F.S.,
BETWEEN
SOUTHWEST FLORIDA WATER MANAGEMENT DISTRICT
AND
DEPARTMENT OF ENVIRONMENTAL PROTECTION**

I. INTENT

The Southwest Florida Water Management District (DISTRICT) and the State of Florida Department of Environmental Protection (DEPARTMENT) enter into this operating agreement (Agreement) to further streamline environmental permitting, while protecting the environment. This Agreement divides responsibility between the DISTRICT and the DEPARTMENT for the exercise of their authority regarding permits, compliance, and enforcement under Part IV, Chapter 373, F.S. This Agreement also divides responsibility between the DISTRICT and DEPARTMENT regarding formal wetland determinations pursuant to Subsection 373.421(2) through (5), F.S. It is a goal of this Agreement that the division of responsibilities provide no reduction in levels of compliance monitoring and enforcement and, where possible, allow increased levels of compliance monitoring and enforcement.

This Agreement supersedes the following agreements: Operating Agreement Concerning Management and Storage of Surface Waters Regulation, and Wetland Resource Regulation Between Southwest Florida Water Management District and Department of Environmental Regulation, dated August 10, 1992; First Amendment to Operating Agreement Concerning Management and Storage of Surface Waters Regulation, and Wetland Resource Regulation Between Southwest Florida Water Management District and Department of Environmental Regulation, dated February 17, 1994; Operating Agreement Concerning Regulation Under Part IV, Chapter 373, F.S., Between Southwest Florida Water Management District and Department of Environmental Protection, dated September 27, 1994; and Operating Agreement Concerning Regulation Under Part IV, Chapter 373, F.S., and Aquaculture General Permits Under Section 403.814, F.S., Between Southwest Florida Water Management District and Department of Environmental Protection, dated October 27, 1998.

As a future step to further increase the efficiency and effectiveness of environmental permitting, the DISTRICT and the DEPARTMENT shall jointly pursue further integration and streamlining of federal and state wetlands regulations.

II. RESPONSIBILITIES OF DISTRICT AND DEPARTMENT

A. DEPARTMENT Responsibilities

1. Permits and Variances

The DEPARTMENT shall review and take final action on all applications for permits and petitions for variances, under Part IV, Chapter 373, F.S., and variances or waivers under Section 120.542, F.S., for the project types listed in a. through t. below. The permit applications encompassed within the DEPARTMENT'S responsibilities hereunder include those submitted for wetland resource (dredge and fill) permits and management and storage of surface waters (MSSW) permits, pursuant to Subsections 373.414(11) through (16), F.S., as well as those submitted for environmental resource permits.

a. All solid waste management facilities that require a permit under Chapter 403, F.S. However, the DISTRICT shall review and take final action on permit applications when the solid waste management facility qualifies for a solid waste general permit and is merely an incidental component of a project for which the DEPARTMENT does not review and take final action on permit applications under any other paragraph in Section II.A.1. of this Agreement.

b. Hazardous waste facilities that require a permit under Chapter 403, F.S. However, the DISTRICT shall review and take final action on permit applications when the storage of hazardous waste is merely an incidental component of a project for which the DEPARTMENT does not review and take final action on permit applications under any other paragraph in Section II.A.1. of this Agreement.

c. Domestic or industrial wastewater treatment, storage, transmission, effluent disposal, or water reuse facilities that require a permit under Chapter 403, F.S. This includes all facilities and activities located at the domestic or industrial wastewater treatment facility; all reuse sites permitted under Parts II or IV, Chapter 62-610, F.A.C.; land application sites permitted under Part VI, Chapter 62-610, F.A.C.; and wetlands created using reclaimed water from domestic wastewater or industrial wastewater sources. However, the DISTRICT shall review and take final action on permit applications for:

(1) Water reuse sites permitted under Part III, Chapter 62-610, F.A.C., such as facilities for the storage and application of reclaimed water to irrigate crops, golf courses, or other landscapes;

(2) Activities involving the application of reclaimed water to rehydrate wetlands or to provide artificial recharge to reduce or mitigate drawdown impacts due to well withdrawals;

(3) Those facilities that are subject to any of the requirements of Chapters 40D-4 or 40D-40, F.A.C., through a system or activity which is not fully

contained on the domestic or industrial wastewater facility site, but which is part of a larger project for which the DEPARTMENT does not review and take final action on permit applications under any other paragraph in Section II.A.1. of this Agreement;

(4) Those facilities that qualify for a general or generic permit pursuant to Rules 62-660.801, F.A.C. (General Permit for a Wastewater Disposal System for a Laundromat), 62-660.802, F.A.C. (General Permit for a Pesticide Waste Degradation System), 62-660.803, F.A.C. (General Permit for Car Wash Systems), 62-660.805, F.A.C. (General Permit for Disposal of Tomato Wash), or 62-621.300(2), F.A.C. (Generic Permit for Discharge of Produced Ground Water from any Non-Contaminated Site Activity); and

(5) Those facilities in which the industrial wastewater component is merely an HVAC (heating, ventilation, and air conditioning) cooling tower discharge, or other industrial wastewater treatment facility which is merely an incidental component of a project for which the DEPARTMENT does not review and take final action on permit applications under any other paragraph in Section II.A.1. of this Agreement.

d. Potable water facilities that require a permit under Chapter 403, F.S. This includes drinking water treatment plants as well as distribution mains. However, the DISTRICT shall review and take final action on permit applications for distribution lines that are fully contained within systems for which the DEPARTMENT does not review and take final action on permit applications under any other paragraph in Section II.A.1. of this Agreement;

e. All mines as defined in Chapter 378, F.S. However, the DISTRICT shall review and take final action on permit applications for sand, shell, and clay mines, other than fuller's earth, mines that do not involve processing other than the use of a scalping screen to remove large rocks, wood, and debris.

f. Power plants and electrical distribution and transmission lines and other facilities related to the production, transmission and distribution of electricity. However, the DISTRICT shall review and take final action on electrical distribution lines fully contained within any larger plan of development for which the DEPARTMENT does not review and take final action on permit applications under any other paragraph in Section II.A.1. of this Agreement.

g. Communication cables and lines. However, the DISTRICT shall review and take final action on communication cables and lines fully contained within any larger plan of development for which the DEPARTMENT does not review and take final action on permit applications under any other paragraph in Section II.A.1. of this Agreement.

h. Natural gas or petroleum exploration, production, and distribution activities and facilities, product pipelines, and other facilities related to the exploration, production, and distribution of natural gas and petroleum. However, the DISTRICT shall review and take final action on natural gas distribution lines fully contained within any

larger plan of development for which the DEPARTMENT does not review and take final action on permit applications under any other paragraph in Section II.A.1. of this Agreement.

i. Docking facilities, boardwalks, shore protection structures and piers, including the adjacent docking and boating related development and navigational dredging. Adjacent docking and boating related development includes parking areas for the docking facility, dry storage facilities, boat sale and supply facilities, maintenance and repair facilities, associated seafood loading and processing facilities, restaurants, harbor master and marina administration facilities. Residential development and other commercial development are not considered docking or boating related. The DEPARTMENT shall also review and take final action on permit applications for docking, boating related, boardwalk, shore protection or pier projects which include existing project related commercial or residential development that does not have a previously issued DISTRICT permit under Part IV, Chapter 373, F.S., and which do not propose new project related commercial or residential development. The DISTRICT shall review and take final action on permit applications for all docking facilities, boardwalks, shore protection structures and piers, including adjacent docking and boating related development and navigational dredging, whenever such facilities are part of a larger plan of other commercial or residential development that has received or requires a permit under Part IV, Chapter 373, F.S.

j. Systems proposed in whole or in part seaward of the coastal construction control line (CCCL). The CCCL has been established in the following counties: Pinellas through those portions of Charlotte within the area of the DISTRICT. In counties where a CCCL has not been established, systems proposed in whole or in part seaward of a point 50 feet above the mean high water line at any riparian coastal location fronting the Gulf of Mexico shoreline, exclusive of bays, inlets, rivers, bayous, creeks, passes, and the like.

k. Projects constructed, operated or maintained by the DISTRICT. However, activities of the DISTRICT permitted under Sections 403.91 through 403.929, F.S., or the rules adopted pursuant to those statutes, and activities of the DISTRICT which did not require a permit under such statutes or rules, shall not require a permit under Part IV, Chapter 373, F.S., provided such activities are part of a project which was commenced prior to October 3, 1995.

l. Navigational dredging constructed, operated or maintained by governmental entities except where associated with a larger project that is otherwise the responsibility of the DISTRICT for review and final action.

m. Seaports and adjacent seaport related development where the applicant or property owner is a port authority as defined in Subsection 315.02(2), F.S.

n. A system serving or consisting of up to three contiguous parcels of land under single ownership where each parcel contains or is proposed to contain only one

single-family dwelling unit, i.e. detached single-family, duplex, triplex or quadraplex (hereinafter referred to as a residential unit), except where the residential unit is only an incidental part of a parcel that is otherwise used for agricultural activities for which a permit has been issued or is required under Part IV, Chapter 373, F.S.

o. The following systems in wetlands or other surface waters when they are not part of a larger plan of development for which the DISTRICT reviews and takes final agency action under any other paragraph of this Agreement: boat ramps, ski jumps, ski slalom courses, aids to navigation, mooring buoys and fields, piling supported structures which are not physically connected to uplands, aquatic plant management activities regulated under Chapter 369, F.S., fish, attractors, artificial reefs, treasure salvage, archeological research or exploration, and removal of organic detrital material.

p. Temporary systems proposed for commercial film productions.

q. High speed rail facilities under Sections 341.8201 through 341.842, F.S.

r. Aquaculture activities not exempt pursuant to Subsection 373.406(8), F.S.

s. All activities on sovereignty submerged lands leased by the Division of Recreation and Parks, except those proposed by the DEPARTMENT.

t. Projects constructed, operated or maintained by the U.S. Army Corps of Engineers.

2. Formal Determinations

The DEPARTMENT shall review and take final action on petitions for formal determinations of the extent of wetlands and other surface waters pursuant to Section 373.421, F.S., filed by entities regarding properties on which they propose to undertake activities for which the DEPARTMENT would have permitting responsibility under this Agreement.

The DEPARTMENT shall provide the DISTRICT with copies of formal determinations of the extent of wetlands or other surface waters issued by the DEPARTMENT.

3. Mitigation Banks and Regional Offsite Mitigation Area Agreements (ROMA)

The DEPARTMENT shall review and take final action on all permit applications for mitigation banks and ROMA agreement proposals, under Sections 373.4135 and 373.4136, F.S., filed by one of the following:

a. Entities proposing to use DISTRICT-owned lands.

b. Governmental entities, excluding the DEPARTMENT, proposed solely to offset the impacts of single-family residential units, pursuant to Subsection 373.4135(6),

F.S., for which the DEPARTMENT reviews and takes final action under Section II.A.1. of this Agreement.

- o. The DISTRICT.

B. DISTRICT Responsibilities

1. Permits and Variances

The DISTRICT shall review and take final action on all applications for permits, petitions for variances, and petitions for formal determination under Part IV, Chapter 373, F.S., and variances and waivers under Section 120.542, F.S., except for those identified as the DEPARTMENT'S responsibility under this Agreement, and except as provided in Section II.E. of this Agreement. The permit applications encompassed within the DISTRICT'S responsibility hereunder include those submitted for wetland resource permits and MSSW permits under Subsections 373.414(11) through (16), F.S., as well as those submitted for environmental resource permits. The DISTRICT shall provide the DEPARTMENT with copies of formal determinations of the extent of wetlands or other surface waters issued by the DISTRICT.

2. DEPARTMENT Projects

The DISTRICT shall review and take action on projects constructed, operated or maintained by the DEPARTMENT. However, activities of the DEPARTMENT permitted under Sections 403.91 through 403.929, F.S., or the rules adopted pursuant to those statutes, and activities of the DEPARTMENT which did not require a permit under such statutes or rules, shall not require a permit under Part IV, Chapter 373, F.S., provided such activities are part of a project which was commenced prior to October 3, 1995.

C. Incorrectly Submitted Applications and Petitions; Modifications

Permit applications, petitions for variances or waivers, and petitions for formal determinations submitted to the incorrect agency pursuant to the terms of this Agreement shall be forwarded to the correct agency for further processing within 10 days of receipt, except where the agencies mutually agree that the application may be retained by the incorrect agency, in which case a special case agreement shall be executed in accordance with Section II.D. of this Agreement. A refund of any fee submitted to the incorrect agency that does not retain processing of the application shall be made to the applicant. Prior to transferring the application, the incorrect receiving agency shall coordinate with the proper reviewing agency and the applicant in order to inform all parties that the application has been submitted incorrectly and is being forwarded.

Notwithstanding Sections II.A. and II.B. of this Agreement permit modification requests shall be processed by the agency issuing the original permit. If the permit has been modified, the agency that issued the last modification to the permit shall process the modification. However, the following two exceptions apply:

1. The DEPARTMENT shall process all modifications to permits for the following activities:

a. Solid waste management facilities as described in Section II.A.1.a. of this Agreement;

b. Mining projects as described in Section II.A.1.o. of this Agreement, when the modification involves the addition of new lands to the permit or the expansion of mining activities into areas not previously approved for mining; and

c. Seaports and seaport related development as described in Section II.A.1.n. of this Agreement.

2. Alterations to stormwater systems previously authorized under Rules 17-25.040 or 62-25.040, F.A.C., shall not be considered as modifications under the provisions of this Section, and shall be processed by the agency that would have responsibility for reviewing and taking final agency action on the system under Sections II.A. and II.B. of this Agreement.

D. Special Cases

By written agreement between the DISTRICT and the DEPARTMENT, responsibilities may deviate from the responsibilities outlined in Sections II.A., II.B., or II.C. above. Instances where this may occur include the following:

1. An extensive regulatory history or a proprietary interest by either the DISTRICT or the DEPARTMENT with a particular project that would make a deviation result in more efficient and effective regulation. This may include activities on lands with a conservation easement held by the other agency;

2. Simplification of the regulation of a project that crosses water management district boundaries;

3. The incorrect agency has begun processing an application or petition and transfer of the application or petition would be inefficient; or

4. Circumstances in which a deviation would result in the application or petition being more efficiently or effectively processed.

The Governing Board may delegate authority to staff to execute special case agreements.

**III. DELEGATION OF AUTHORITY: MIXING ZONES,
ZONES OF DISCHARGE, VARIANCES**

A. The DEPARTMENT delegates authority to the DISTRICT to review and take final action on requests for zones of mixing in surface waters and zones of discharge in ground water, in accordance with Sections 62-4.242, 62-4.244, 62-28.700, 62-522.400 and 62-522.410, F.A.C., when the requests are associated with a permit application for which the DISTRICT is responsible under the terms of this Agreement.

B. The DEPARTMENT delegates the authority to the DISTRICT to take action on petitions for variances or waivers from state water quality standards in accordance with Sections 120.542, 373.414(17) and 403.201, F.S., when the petition is associated with a permit application for which the DISTRICT is responsible under the terms of this Agreement.

IV. COMPLIANCE MONITORING AND ENFORCEMENT

A. Division of Responsibilities

Each agency shall perform compliance monitoring on all projects for which that agency has issued a permit, consent order, final order, or for which a consent final judgment or final judgment has been entered to determine compliance with the conditions thereof and will enforce said conditions by taking appropriate enforcement action where necessary. However, if the DEPARTMENT or the DISTRICT modifies a permit previously issued by the other agency, pursuant to this Agreement, the agency modifying the permit shall thereafter determine compliance with the permit and enforce all provisions or conditions of that permit.

Each agency shall investigate activities regulated under Part IV, Chapter 373, F.S., that are undertaken without the required permits, and take appropriate enforcement action, when it has permitting responsibilities for those activities under this Agreement.

When a violation of Part IV, Chapter 373, F.S., also constitutes a violation of Chapters 253 or 258, F.S., and the resolution of the violation under Part IV, Chapter 373, F.S., does not resolve the violation under Chapters 253 or 258, F.S., the DISTRICT shall coordinate compliance and enforcement actions with the DEPARTMENT, and shall forward a copy of the enforcement documentation generated on those violations to the DEPARTMENT for its use in addressing the violation under Chapters 253 or 258, F.S.

B. Special Cases

By written agreement between the DISTRICT and the DEPARTMENT, enforcement responsibilities for specific cases may deviate from the responsibilities outlined in Section IV.A. of this Agreement. Instances where this may occur include:

1. The case also includes activities that may be violations of rules of the DISTRICT or the DEPARTMENT that are not the subject of this Agreement;
 2. The case involves activities that cross water management district boundaries; or
 3. Deviation would result in the case being more effectively or efficiently handled.
- The Governing Board may delegate authority to staff to execute special case agreements.

V. EMERGENCIES

In a declared emergency, pooling of staff resources and deviations from the terms of this Agreement may be in the best interest of the public service and protecting or restoring property and environmental resources. Therefore, notwithstanding the divisions of responsibilities specified in this Agreement, where the Governor has issued an Executive Order which declares an emergency and the DISTRICT and the DEPARTMENT have issued emergency orders to implement the Executive Order, either party to this Agreement can review and take agency action on any activities regulated under Part IV, Chapter 373, F.S., that are authorized by an emergency order during the duration of the emergency orders of the DISTRICT and the DEPARTMENT.

VI. INTERAGENCY COMMITTEE

In order to seek consistency in the Environmental Resource Permit (ERP) Program and to facilitate the implementation of the DEPARTMENT'S responsibilities under Subsection 373.026(7), F.S., and Section 62-340.100, F.A.C., the DISTRICT and the DEPARTMENT agree to form and participate in an ERP Committee (Committee). The Committee shall meet at least twice a year, but may meet more frequently as issues arise that require interagency coordination. The Committee shall provide a forum for the DEPARTMENT and water management districts to coordinate and communicate regarding the following:

1. Joint training efforts to maximize the use of training resources and ensure that adequate training is provided.
2. Promotion of consistent interpretation and implementation of ERP rules.
3. Proposed amendments to ERP rules.
4. Development of consistent ERP compliance and enforcement.
5. Future revisions to the DISTRICT and the DEPARTMENT operating agreements regarding the ERP program.

6. Development of a statewide ERP data set and a computer data exchange methodology.
7. Such other activities that the committee deems necessary or desirable to achieve and maintain the goals of this Agreement.

VII. EFFECTIVE DATE

This Agreement shall take effect July 1, 2007.

Applications, petitions, and enforcement cases, under Part IV, Chapter 373, F.S., which are pending on the effective date of this Agreement shall continue to be processed by the agency to which application or petition was made or which initiated the enforcement case, except when the DISTRICT and the DEPARTMENT agree, and in the case of an aquaculture activity the applicant also agrees, that an application, petition or enforcement case should be transferred in order to provide for more efficient processing and enforcement. Applications and petitions received after the effective date of this Agreement will be processed as described in Section II of this Agreement.

AGREED TO this 1st day of July, 2007.

SOUTHWEST FLORIDA WATER
MANAGEMENT DISTRICT

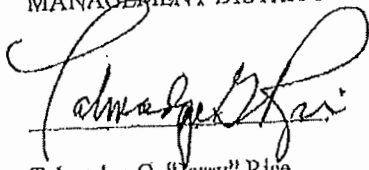

Talmadge G. "Jerry" Rice
Chair, Governing Board
2379 Broad Street
Brooksville, FL 34604-6899

STATE OF FLORIDA DEPARTMENT
OF ENVIRONMENTAL PROTECTION

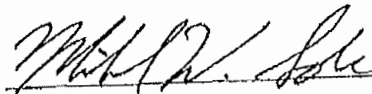

Michael W. Sole
Secretary
2600 Blair Stone Road
Tallahassee, FL 32399-2400

APPENDIX E

FLEXIBILITY FOR STATE TRANSPORTATION PROJECTS AND FACILITIES

State linear transportation projects and facilities (collectively referred to as "projects" in this section) often have unique design limitations. In recognition of this, subsection 373.413(6), F.S., requires the Agency to consider and balance the expenditure of public funds for stormwater treatment with the benefits to the public in providing the most cost-efficient and effective method of achieving the treatment objectives of stormwater management systems when reviewing such projects. To accomplish this, alternatives to on-site treatment for water quality will be considered, including regional stormwater treatment systems, off-site compensating treatment, and incorporation of off-site runoff into the treatment system for the project.

The incorporation or comingling of off-site runoff into the treatment system for the project is often a more cost effective design when compared to routing off-site runoff around the system. In most cases the comingling of off-site stormwater runoff into the system will also provide for increased pollutant removal when compared to the design option of routing it around the system even if the system is designed to only meet the design and performance standards of Volume II for the runoff from just the on-site project area. However, for undeveloped or unimproved offsite areas co-mingling into an onsite FOOT retention type treatment system, the design capacity of the on-site system may need to be evaluated in order to ensure that there is no harm to the existing conditions. Such instances should be evaluated on a case-by-case basis.